

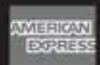

Specializing in 1948 - 1956 Ford Truck Parts



To Order Call 1-800-621-5030
Order Online at www.CMWTrucks.com



Cab Mounting - Pg 10



CMW-0711 - 48-56 Adjustable Cab Mount Arm

One Piece Window Kits - Pg 18



Bed Pg 2

Bumpers Pg 8

Fenders - Rear Pg 9

Cab Mounting Pg 10

Door Handles, Locks & Latches Pg 12

Glass Parts & Mirrors Pg 15

Glass Pg 16

Weatherstrip Pg 17

Emblems & Grille Pg 20

Front Fenders & Core Support Pg 22

Hood Pg 24

Patch Panels Pg 26

Running Boards Pg 30

Brakes Pg 31

Original Steering Pg 35

Steering Upgrade Pg 36

Suspension Pg 37

Electrical Pg 41

Engine/Trans Mounts Pg 50

Fuel System Pg 52

Dash Pg 54

Interior Pg 57

Wipers Pg 60

Altman Easy Latch Kits - Pg 14



Hood Parts - Pg 24

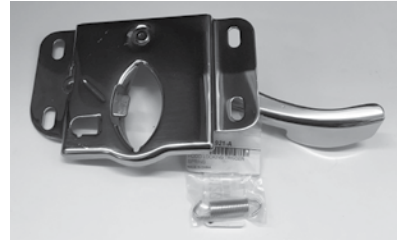

Body Patch Panels - Pg 26



Brake Upgrades - Pg 32



Power Steering - Pg 36



Electrical - Pg 41



Lighting - Pg 45



Wiper Kits - Pg 61



» Bed - Complete Kits

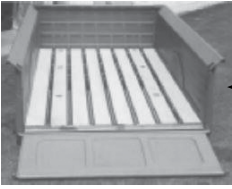

Complete 48-50 Stock Bed Kit (Has correct stamping in bedsides)

48-50 Stock Bed Kit - Tailgate and Fenders sold separately MEF-8C-830000 \$2,495

** Price includes crate charge

This is our 1948, 1949, Early 1950 Ford F1 Shortbed Stepside Complete Bed Kit.

Stake pocket holes are cut in bedsides like the original.

Parts Included in Kit

- » 1 Front Bed Panel
- » 1 Pair of Bedside Assemblies (Stake pocket holes in bedsides are cut in)
- » Subframe Rails/Crossmembers
- » 2 Tailgate Chains
- » 2 Tailgate Hinges (Part of the Stainless Steel Option)
- » 1 Floor Adapter Kit - wood
- » 1 Set of Oak Bedwood
- » 1 Set of Steel Strips (Part of the Stainless Steel Option)
- » 1 Cap Strip for Back Edge of Floor
- » 1 Complete Bed assembly Bolt Kit - includes fender bolts (Part of the Stainless Steel Option)

Notes on this bed:

- » Pre-Fit for easier assembly
- » Fenders not included
- » May take up to 3 weeks to ship

Choose the Stainless Steel Option to Upgrade These Parts (add \$254)

- » SS bed strips
- » SS bolts for hold down and strips
- » SS Tailgate hinges
- » SS Rear Fender bolts

SHIPPING WILL HAVE TO BE QUOTED PLEASE CALL -
IT'S CHEAPER TO SHIP FREIGHT TO A BUSINESS
GENERALLY. YOU CAN ALSO SAVE BY PICKING THE
BED UP AT THE SHIPPING DOCK NEAR YOU,
IF THAT'S AN OPTION.



Complete 50-52 Stock Bed Kit

50-52 Stock Bed Kit - Tailgate and Fenders sold separately MEF-1C-830000 \$1,749

** Price includes crate charge

This is our Late 1950, 1951, 1952 Ford F1 Shortbed Stepside Complete Bed Kit.

NO stake pocket holes in bedsides - They are NOT cut in.

Parts Included in Kit

- » Front Bed Panel
- » 1 Pair of Bedside Assemblies (NO stake pocket holes in bedsides - They are not cut in)
- » 1 Pair Tailgate Hinges (Part of the SS option)
- » 1 Pair Tailgate Chains
- » 1 Front Crossmember
- » 2 Middle Crossmembers
- » 1 Rear Crossmember - with brackets
- » 1 Set of Bedwood
- » 1 Set of Steel Strips (Part of the SS option)
- » Set of bed bolts (Part of the SS option)
- » 1 Cap Strip for Back Edge of Floor
- » 1 Complete Bed Assembly Bolt Kit
- » Includes Fender bolts (Part of the SS option)

Notes on this bed:

- » Fender Holes are pre-drilled
- » 16 Gauge Steel
- » Pre-Fit for easier assembly
- » Fenders and Tailgate sold separately
- » Crating Charge is included in price
- » Beds are sent un-assembled

Choose the Stainless Steel Option to Upgrade These Parts (add \$200)

- » SS bed strips
- » SS bolts for hold down and strips
- » SS Tailgate hinges
- » SS Fender bolts

**SHIPPING WILL HAVE TO BE QUOTED PLEASE CALL -
IT'S CHEAPER TO SHIP FREIGHT TO A BUSINESS
GENERALLY. YOU CAN ALSO SAVE BY PICKING THE
BED UP AT THE SHIPPING DOCK NEAR YOU,
IF THAT'S AN OPTION.**



» Bed - Complete Kits



Complete 53-56 Stock Bed Kit

53-56 Stock Bed Kit - Complete Except Tailgate.....\$1,695

****Crating Charge is added to cover the time and material to crate up this large item
This is our 1953, 1954, 1955, 1956 Ford F100 Stock Steel Bed Kit.**

Parts Included in Kit

- » Front Bed Panel
- » 1 Pair of Bedside Assemblies - Choose Below: With or W/O stake pocket holes
- » 1 Pair Tailgate Hinges
- » 1 Pair Tailgate Chains
- » 1 Front Crossmember
- » 2 Middle Crossmembers
- » 1 Rear Crossmember - with brackets
- » 1 Set of Bedwood
- » 1 Set of Steel Strips
- » 1 Cap Strip for Back Edge of Floor
- » 1 Complete Bed Assembly Bolt Kit - Includes Fender bolts*
- » Tailgate is not included

Notes on this bed:

- » Fender Holes are pre-drilled
- » 16 Gauge Steel - comes unprimed/has the light oil coating to stop surface rust
- » Pre-Fit for easier assembly
- » Fenders & Tailgate not included
- » Crating Charge is included
- » Beds are sent un-assembled
- » Depending on the time of year, it may take 2-6 weeks for delivery.

Choose the Stainless Steel Option to Upgrade These Parts (add\$200)

- » SS bed strips
- » SS bolts for hold down and strips
- » SS Tailgate hinges
- » SS Fender bolts
- » SS Cap Strip below tailgate

**SHIPPING WILL HAVE TO BE QUOTED PLEASE CALL -
IT'S CHEAPER TO SHIP FREIGHT TO A BUSINESS
GENERALLY. YOU CAN ALSO SAVE BY PICKING THE
BED UP AT THE SHIPPING DOCK NEAR YOU,
IF THAT'S AN OPTION.**



Bed Mounting Diagram

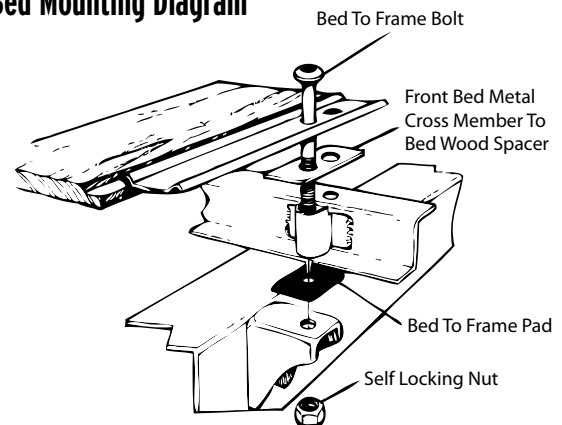

Bedside

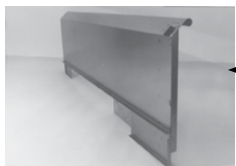

48-50 Bedside - Complete - Stepside Shortbed - LH.....	MEF-8C-830500.....	\$475
48-50 Bedside - Complete - Stepside Shortbed - RH.....	MEF-8C-830501.....	\$475
50-52 Bedside - Complete - Stepside Shortbed - LH.....	MEF-1C-830500.....	\$299
50-52 Bedside - Complete - Stepside Shortbed - RH.....	MEF-1C-830501.....	\$299
53-56 F100 SHORT Bedside - LH - NO Stake Pock. Holes.....	CMW-5356BS-L-N.....	\$325
53-56 F100 SHORT Bedside - RH - NO Stake Pock. Holes Truck Freight.....	CMW-5356BS-R-N.....	\$325
53-56 F100 SHORT Bedside - LH - w/Stake Pock. Holes Truck Freight.....	CMW-5356BS-L-WS.....	\$325
53-56 F100 SHORT Bedside - RH - w/Stake Pock. Holes Truck Freight.....	CMW-5356BS-R-WS.....	\$325
38-50 Stake Pocket - LH or RH.....	MEF-81C-830522.....	\$49
50-72 Bed Stake Pocket - Front or Rear - LH or RH.....	MEF-8C-830532.....	\$32
53-56 Bedside Extension - Front - Pair.....	CMW-5372FBE-PR.....	\$36
53-56 Bedside Extension - Rear - Pair.....	CMW-5372RBE-PR.....	\$25
48-72 Ford Bed Stake Pocket Extensions - Rounded - Pair - Fit Front or Rear.....	CMW-0229.....	\$49 pair

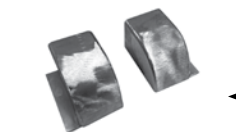

Bedside Customization



50-72 Bed Teardrops for Bed Roll - Set of 4.....	CMW-0218-4.....	\$19.00
--	-----------------	---------

Front Bed Panel



42-50 Front Bed Panel - Stepside Shortbed.....	MEF-21C-8300124.....	\$199
51-72 Front Bed Box Panel.....	MEF-BAAA-8300124.....	\$199
50-72 Front Bed Panel Stainless Trim Cover With Pointed Ends.....	CMW-0219-PT.....	\$45

Bed Sills & Crossmembers (6'-6" Bed unless noted otherwise)

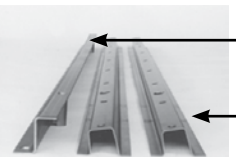

42-50 Front Bed Crossmember (USA Made).....	MEF-21C-8310610-A.....	\$49
42-50 Middle Front Bed Crossmember (USA Made).....	MEF-21C-8310705-F.....	\$55
42-50 Middle Rear Bed Crossmember (USA Made).....	MEF-21C-8310705-R.....	\$55
42-50 Rear Bed Crossmember (USA Made).....	MEF-21C-830108.....	\$75
50-52 Front Bed Crossmember (USA Made).....	MEF-1C-8310610-A.....	\$49
53-72 Front Bed Crossmember - (USA Made).....	MEF-BAAA-8310610-A.....	\$45
53-72 Front Bed Crossmember - (Taiwan Made).....	AMD-716-4553-1.....	\$49
50-72 Front Bed Crossmember - Hidden Mount.....	CMW-0230-HD.....	\$49
50-72 Middle Bed Crossmember - Shortbed - Need 2 per bed (USA Made).....	MEF-BAAA-8310705.....	\$55 each
50-72 Middle Bed Crossmember (Taiwan).....	AMD-716-4551-2.....	\$45
50-72 Rear Bed Crossmember - Stepside - Short bed (USA Made).....	MEF-BAAA-830108-A.....	\$79
50-72 Rear Bed Crossmember - Rear Sill W/OE Style Mounts - Longbed Only	CMW-F2-0234.....	\$345

Bed Strips & Bed Floor



48-52 Bed to Frame Pad Set - Set of 8.....	DC-7C-8144155-S.....	\$8
42-72 Bed to Frame Pads - Set of 8.....	DC-BAAA-8144155-S.....	\$8
48-56 Bed Side to Wood Floor Seal.....	DC-7C-8144150-S.....	\$15 pair
48-72 Front Bed Crossmember to Wood Spacer (Steel).....	DC-8C-8110611-PR.....	\$4 pair

Bed Strips & Bed Floor (continued)

42-50 Bed Strip Bolt Kit - Steel.....	CMW-4250SBK.....	\$11
42-50 Bed Strip Bolt Kit - Stainless Steel.....	CMW-4250SBK-SS.....	\$39
50-72 Bed Strip Bolt Kit - Steel - Shortbed Stepside.....	CMW-5060SBK.....	\$22
50-72 Bed Strip Bolt Kit - Stainless Steel - 6' Bed.....	CMW-5060SBK-SS.....	\$40
42-50 Bed Skid Strip (Steel or SS).....	MEF-21C-8312605.....	\$15.00 - \$21.00
48-52 Bed Strip Set- Short Bed - Paintable Steel.....	TRU-1205.....	\$119
48-52 Bed Strip Set- Short Bed - Stainless Set - Not Polished.....	TRU-1183.....	\$175
48-52 Bed Strip Set - Short Bed - Polished Stainless Steel.....	TRU-1181.....	\$239
53-60 Bed Strip Set - Short Bed - Paintable Steel.....	TRU-1207.....	\$119
53-60 Bed Strip Kit - Short Bed - Stainless Set - Not Polished.....	TRU-1187.....	\$175
53-60 Bed Strip Set - Short Bed - Polished Stainless Steel.....	TRU-1185.....	\$239
42-50 Bed Mounting Bolt Kit - Stainless Steel.....	CMW-4250BMK-SS.....	\$39
42-50 Bed Mounting Bolt Kit - Steel.....	CMW-4250HDB.....	\$26
50-52 Bed To Frame Bolt Kit - Stainless Steel.....	CMW-5052HDBSS.....	\$26
50-52 Bed To Frame Bolt Kit - Steel.....	CMW-5052HDB.....	\$23
53-72 Bed to Frame Mounting Kit - Short Bed - Stainless.....	CMW-5372HDBSS.....	\$26
53-72 Bed to Frame Mounting Bolt Kit- Short Bed - Steel.....	CMW-5372HDB.....	\$19
48-72 Bed Washer (Hold Down) - Stepside - Steel.....	DC-7C-8144440.....	\$2 each
48-72 Bed Washer (Hold Down) - Stepside - Stainless.....	DC-7C-8144440-SS.....	\$3 each
42-50 Bed Sub-Frame Rails - Pair.....	MEF-21C-8310249/50-PR.....	\$199.00
38-50 Bedwood Cap Strip - Stainless Steel.....	MEF-81C-8312609-SS.....	\$45
42-50 Bedwood Cap Strip - Steel.....	MEF-7C-8312609-P.....	\$22
51-72 Bed Board End Cap - Steel.....	CMW-5072CS.....	\$22
51-72 Bed Board End Cap - Polished Stainless Steel.....	MEF-BAAA-8312609-SS.....	\$45
42-50 Custom Red Oak Bed Wood Floor Kit - Unfinished.....	MEF-21C-8312606.....	\$340
42-50 Custom Oak Bed Wood Floor Kit.....	MEF-21C-8312606-P.....	\$449
42-50 Custom Oak Bed Wood Floor Kit - Stainless Steel.....	MEF-21C-8312606-SSK.....	\$599
50-56 Oak Bed Wood Kit - Short Bed - Stepside 6'-6" Bed.....	CMW-5056BW.....	\$325

Tailgate & Related

42-72 Tailgate Hinge - Stepside - Stainless.....	DC-8C-8343018-SS.....	\$15 each
42-87 Tailgate Hinge - Stepside - Plain Steel.....	DC-8C-8343018.....	\$7 each
48-56 Tailgate Chain Cover - Black Rubber.....	DAL-7C-44450-81B.....	\$12 pair
42-50 Tailgate Chain Set - Stainless Steel.....	DC-21C-8344456-SS.....	\$79
51-52 Tailgate Chain Assembly Set - Stainless Steel.....	DC-1C-8344456-SS.....	\$79
53-72 Tailgate Chain Assembly Set - Plain Steel.....	DC-BAAA-8344456-A.....	\$79
53-72 Tailgate Chain Assembly Set - Stainless Steel.....	DC-BAAA-8344456-SS.....	\$125



Tailgate & Related (continued)

42-50 Tailgate - OEM Type - F1 Only.....	MEF-21C-8340700.....	\$325
51-52 Tailgate - OEM Type - F1 Only.....	MEF-1C-8340700.....	\$325
48-72 Tailgate - Smooth - No Ears For Chains.....	MEF-B7C-8340700-SM.....	\$229
53-72 Tailgate - Stepside Shortbed - OEM Type Fit.....	DC-B7C-8340700-A.....	\$440
53-72 Tailgate - Stepside Shortbed - OE - NO Chain Ears.....	DC-B7C-8340700-NH.....	\$460
53-79 Tailgate - Stepside Long Bed - OE (SEE SPECIFIC FIT).....	DC-B7D-8340700-A.....	\$480
53-72 Tailgate - Stepside Shortbed - OEM Type Fit - "MERCURY" Lettering.....	MEF-B7M-8340700.....	\$425



DC-B7C-8340700-A
Tailgate - Shortbed - OEM

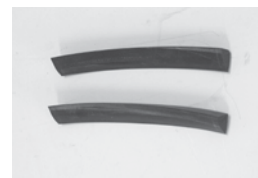

DC-BAAA-8340725-A Tailgate
Side Bumper Set

53-72 Tailgate Side Bumper Set.....	DC-BAAA-8340725-A.....	\$4 pair
53-72 Tailgate Chain Special Rubber Bumpers.....	DC-BAAA-8344458-S.....	\$5 pair

Tailgate Latches

48-87 Tailgate Latch & Cable Kit - Paintable Steel.....	AMD-X927-4000-1S.....	\$249
48-87 Tailgate Latch & Cable Kit - Paintable Steel With Stainless Steel Hardware.....	AMD-X927-4000-2S.....	\$270
48-87 Tailgate Latch & Cable Kit - All Stainless Steel.....	AMD-X927-4000-3S.....	\$340

Tailgate Latches - Custom

Tailgate Latch Flip Style - Inside Bed - Chrome.....	CMW-BAAA-88200-CH.....	\$59
Tailgate Latch Flip Style - Inside Bed - Stainless Steel.....	CMW-BAAA-88200-SS.....	CALL
Stealth Tailgate Latches Stainless Steel - Set.....	CPP-CPSLK-S1.....	\$69



Sold as a Pair

Stealth Tailgate Latches



These take a bit of time to install, but are hidden nicely. They are very slick with very little exposed.

Hidden Tailgate Hinges

37-52 Hidden Tailgate Hinge Kit.....	LM-49-8353.....	\$85
53-56 Hidden Tailgate Hinge Kit.....	PMC-0269.....	\$99



Custom Tailgate Check Strap Kit

Tailgate Check Strap Kit.....	PMC-0266-STP.....	SOON
-------------------------------	-------------------	------



» Bumpers & Brackets

Bumper - Front

48-50 Bumper - Front - Paintable - Also Fits 51-52.....	DC-7C-17750-A.....	\$150
48-52 Bumper - Front - Chrome.....	AMD-100-4548-1.....	\$259
48-52 Bumper - Front - Polished Stainless Steel - Brackets Include.....	DC-7C-17750-SS.....	\$349
51-52 Bumper - Front - Ribbed - Chrome.....	AMD-100-4551-1.....	\$259
53-56 Bumper - Front - Chrome - NO Brackets Included.....	AMD-100-4553-1.....	\$259
53-56 Bumper - Front - Paintable - Brackets Included.....	DC-TAAA-17750-B.....	\$135
53-56 Bumper - Front - Polished Stainless Steel - Brackets Included.....	DC-TAAA-17750-SS.....	\$350
53-56 Bumper - Front - Polished Stainless Steel - NO HOLES.....	DC-TAAA-17750-SS.....	\$325
48-52 Bumper Bracket Set - Front - Paintable.....	DC-7C-17754-P.....	\$40
48-52 Bumper Bracket Set - Front - Polished Stainless Steel.....	DC-7C-17754-SS.....	\$75
53-56 Bumper Bracket Set - Front - Chrome.....	AMD-105-4553-CS.....	\$99
53-56 Bumper Bracket Set - Front - Paintable.....	DC-TAAA-17754-P.....	\$40
53-56 Bumper Bracket Set - Front - Stainless Steel.....	DC-TAAA-17754-SS.....	\$75
53-56 Frame Horn - Front - LH Frame Rail - 11" Long.....	CMW-4002-L.....	\$45
53-56 Frame Horn - Front - RH Frame Rail - 11" Long.....	CMW-4002-R.....	\$45
48-52 Frame Horn Covers - Front - Polished Stainless Steel.....	CMW-0606-4852.....	\$49
53-56 Frame Horn Covers - Front - Polished Stainless Steel.....	MEF-BAAA-17752-SS.....	\$49

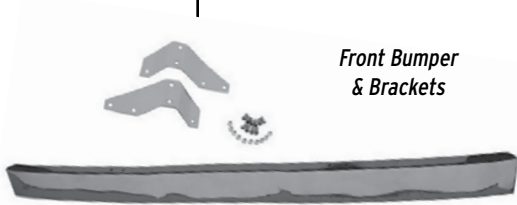

Front Bumper
& Brackets



Rear Bumper

Bumper - Rear

48-72 Bumper - Rear - Paintable.....	DC-BBAA-17906-A.....	\$135
48-72 Bumper - Rear - Chrome.....	AMD-990-4548-1.....	\$269
48-72 Bumper - Rear - Stainless Steel.....	DC-BBAA-17906-SS.....	\$350
48-72 Rear Bumper Bracket Set of 4 - Painted - USA Made.....	MEF-B5C-17787-A.....	\$95
48-72 Rear Bumper Bracket Set of 4 - Paintable.....	OVL-53F-17787-B.....	\$84
48-72 Rear Bumper Bracket Set of 4 - Chrome.....	AMD-970-4553-CS.....	\$165
48-72 Rear "Snugger" Bumper Bracket Set of 4 - Paintable.....	MEF-SB-17787/88-S.....	\$119

- These move the bumper closer toward the frame

» Fenders - Rear

Rear Fender



48-50 Rear Fender - LH - Steel.....	AMD-780-4548-L.....	\$749
48-50 Rear Fender - RH - Steel.....	AMD-780-4548-R.....	\$749
51-52 Rear Fender - LH - Steel.....	AMD-780-4551-L.....	\$749
51-52 Rear Fender - RH - Steel.....	AMD-780-4551-R.....	\$749
53-79 Rear Fender - Stepside - LH - Steel - USA Made.....	DC-BAAA-16313-A.....	\$359
53-79 Rear Fender - Stepside - RH - Steel - USA Made.....	DC-BAAA-16312-A.....	\$359
53-79 Rear Fender - Stepside - LH - Steel - Import.....	AMD-780-4553-L.....	\$375
53-79 Rear Fender - Stepside - RH - steel - Import.....	AMD-780-4553-R.....	\$375
Welting - Fender Welt (30ft) - Black - Enough to do 2 rear fenders & more.....	DC-48-16070.....	\$27
Welting - Fender Welt (30ft) - Chrome - Enough to do 2 rear fenders & more.....	DAL-48-16070-5/32C.....	\$29
Anti-Squeak - 50' Roll.....	DC-M17772-C.....	\$33
48-79 Bedside Rear Fender Bolt, Lock Washer, Nut - Steel.....	DC-355471-S8.....	\$1 each
48-79 Bedside Rear Fender Bolt, Lock Washer, Nut - Stainless Steel.....	DC-355471-S24.....	\$1.50 each
48-79 Bedside Rear Fender Bolt, Lock Washer, Nut - Polised Stainless Steel.....	DC-355471-SS.....	\$2 each
48-79 Ford Rear Fender Bolt Set - Steel.....	DC-355471-SET.....	\$20
48-79 Ford Rear Fender Bolt Set - Stainless Steel.....	DC-355471-S24K.....	\$30
48-79 Ford Rear Fender Bolt Set - Polised Stainless Steel.....	DC-355471-SSK.....	\$40
48-50 Rear Fender Brace - Pair.....	MEF-7C-16340.....	\$32
50-52 Rear Fender Brace - Pair.....	MEF-1C-16340.....	\$32
53-56 Rear Fender Brace - LH or RH - Steel.....	DC-BAAA-16340-A.....	\$11
53-79 Rear Fender Brace Mounting Tab - LH.....	CMW-1535-LH.....	\$16
53-79 Rear Fender Brace Mounting Tab - RH.....	CMW-1535-RH.....	\$16
Custom 1" Diameter Stainless Steel Recessed Finish Washer, Bolt & Nut - Set of 12.....	CMW-5000-SS.....	\$24

Fix Those Rear Fenders!

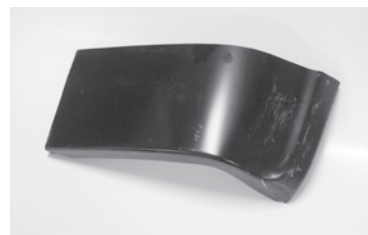

53-79 Rear Fender Repair Panel - LH - Fixes lower front.....	AMD-204-4553-L.....	\$33
53-79 Rear Fender Repair Panel - RH - Fixes lower front.....	AMD-204-4553-R.....	\$33

Roll Pans - Rear

42-Early 50 Roll Pan - Rear - SMOOTH - NO License Plate Box.....	MEF-21C-8301110-P.....	\$199
42-Early 50 Roll Pan - Rear - With License Plate Box Recess.....	MEF-21C-8301110-LR.....	\$279
50-72 Roll Pan - Rear - Stepside - SMOOTH - NO License Plate Box.....	MEF-BAAA-8301110-P.....	\$199
50-72 Roll Pan - Rear - Stepside - With License Plate Box Recess.....	MEF-BAAA-8301110-LR.....	\$279

» Cab Mounting



DC-BAAA-5400-S
53-56 Cab to Frame
Bushing Kit

Cab Mounting

48-52 Cab to Frame Mounting Pad & Bushing Kit	DC-7C-5400-SS	\$25
53-56 Cab to Frame Bushing Kit	DC-BAAA-5400-S	\$22
48-56 Cab to Frame Arm Assembly w/Bushings	DC-7C-5352	\$25
48-56 Ford Truck Adjustable Cab Mount Arm - For Rear Mount	CMW-0711	\$149 Each

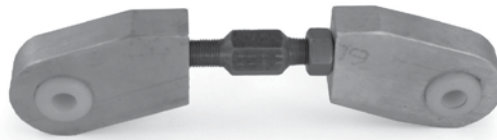

CMW-0711 - 48-56 Adjustable Cab Mount Arm

48-56 Rear Cab Mount Bracket On Frame - Triangle	AMD-425-4548	\$26
53-56 Rear Cab Mount Base Plate - LH or Right	CMW-0738	\$19
53-56 Rear Cab Mount Base Bracket - LH	AMD-425-4553-L	\$23
53-56 Rear Cab Mount Base Bracket - RH	AMD-425-4553-R	\$23
48-52 Cab to Frame Mounting Bolt Kit	DC-7C-5404-KIT	\$27
53-56 Cab to Frame Mounting Bolt Kit (Our Kit -w/Galvanized Sq Washers)	CMW-BAAA-5404	\$13
53-56 Cab to Frame Mounting Bolt Kit - Steel	DC-BAAA-5404-KIT	\$25
53-56 Cab to Frame Mounting Bolt Kit - Stainless Steel	CMW-0008	\$19
53-56 Front Body Mount - LH	DC-BAAA-8102057	\$30
53-56 Front Body Mount - RH	DC-BAAA-8102056	\$30
53-56 Lower Front Cab Mount Retainer - Pair	DC-BAAA-8102060-PR	\$12
53-56 Upper Cab Mount Cups Repair Panels - Pair	DC-BAAA-8102058-PR	\$25
53-56 Front Cab Mount Cap (Part of above part)	PMC-0719	CALL

Front Cab Mounting Diagram

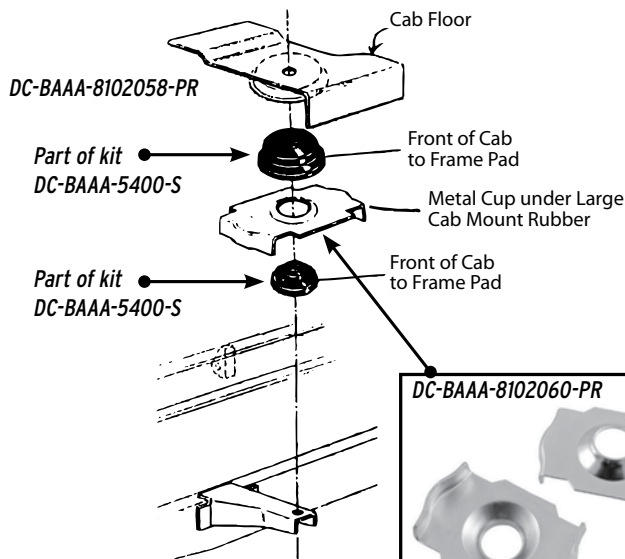

Rear Cab Mounting Diagram

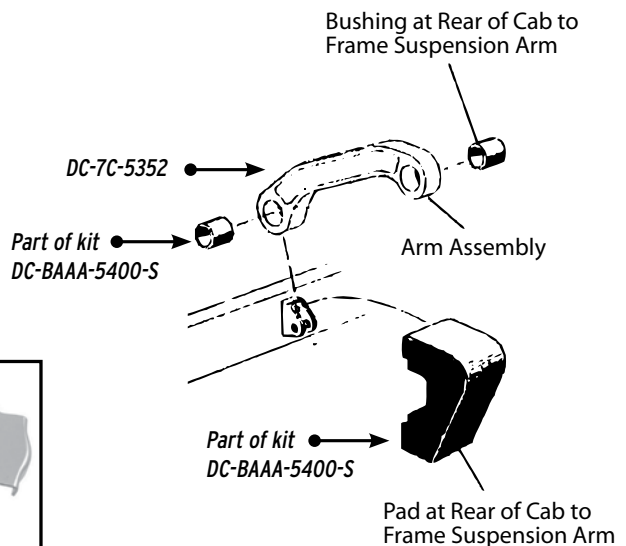

Cab Parts

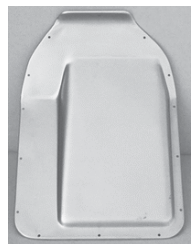

48-52 Firewall Assembly.....	UAP-110440.....	CALL
48-52 Transmission Floor Cover (USA Made).....	MEF-7C-8112108-ST.....	\$99
48-56 Transmission Cover Cage Nuts - Set of 15.....	CMW-2158.....	\$10
48-56 Transmission Cover Screws - Set of 15 - Steel.....	CMW-2157.....	\$5
53-56 Transmission Hole Cover.....	AMD-415-4553-1.....	\$59
42-60 Cowl Lacing - Seal - Rubber - NOT OEM Type.....	DC-B7C-16740.....	\$10
42-56 Cowl Lacing - Seal - OE Cloth Type.....	DC-21C-16740.....	\$16
48-52 Cowl Vent Gasket.....	DC-7C-8102330-A.....	\$12
56 Cowl Vent Handle - Steel.....	CMW-0910-56.....	\$15



53-55 Cab Skirt Channel - Holds the running board to cab seal.....	DC-BAAA-8110112-PR.....	\$20 pair
39 - 52 Ford Truck Master Cylinder Floor Cover Plate.....	DC-91A-7011136.....	\$10
53-56 Cover Plate - Master Cylinder.....	DC-BAAA-8111136.....	\$16
53-55 Gas Sender Inspection Plate (Cab Floor).....	CMW-2133.....	\$15
53-56 Dimmer Switch Floor Plate - Steel.....	CMW-2914-FP.....	\$16

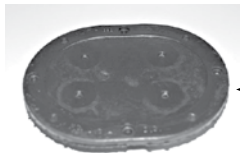

Anti-Squeak - 50' Roll.....	DC-M17772-C.....	\$33
-----------------------------	------------------	------

Battery Hole Covers



53-55 Battery Hole Cover (Locking).....	AMD-341-4553-2.....	\$49
53-55 Battery Hole Cover Seal.....	DC-BAAA-8101645-B.....	\$12
56 Battery Hole Cover (Locking).....	AMD-341-4548-1.....	\$60
56 Seal For Battery Hole Cover.....	DC-B6C-8101645-B.....	\$12



**Scan The QR Code
With Your Mobile Phone's Camera
to go to our website**



» Door/Window Handles



Door & Window Inside Handles

Door & Window Handle Clip Removal Tool.....	LM-31-0800.....	\$10
53-55 Door & Window Crank Handle Clip.....	DC-357550-S.....	\$0.50 each
48-52 Door Handle - Inside.....	DC-7C-8122614.....	\$15
53-55 Door Handle - Inside - With Clip.....	DC-B5C-8122600-A.....	\$15
56 Door Handle - Inside - Set Screw Type.....	DC-B6C-8122600.....	\$15
48-50 Escutcheon For Window / Door Handle.....	DC-7C-8122618.....	\$10
51-52 Escutcheon For Window / Door Handle.....	DC-1C-8122618.....	\$12
53-55 Escutcheon For Window / Door Handle (Stainless Steel & Rubber Ring).....	DC-BAAA-8122618.....	\$8
53-55 Window Handle Escutcheon Spring.....	DAL-B-48284.....	\$1
56 Escutcheon For Window / Door Handle.....	DC-B6C-8122618.....	\$8
48-52 Window Crank Handle.....	DC-7C-8123342.....	\$16
53-55 Window Crank Handle - w/clip.....	DC-B5C-8123342.....	\$15
53-56 Window Crank Handle Knob - Black - With Install Pin.....	DC-BAAA-8123341.....	\$6.50
56 Window Crank Handle - Black Knob.....	DC-B6C-8123342.....	\$15



Outside Door Handles

48-52 Door Handle - Outside LH.....	DC-7C-8122401-A.....	\$40
48-52 Door Handle - Outside RH.....	DC-7C-8122400-A.....	\$40
53-60 Door Handle - Outside LH w/button & Rubber Pads.....	DC-BAAA-8122401-B.....	\$40
53-60 Door Handle - Outside RH w/button & Rubber Pads.....	DC-BAAA-8122400-B.....	\$40
53-56 Door Handle Button Assembly - For one handle.....	DC-BAAA-8122454-A.....	\$15
53-56 Door Handle Shield Set - Polished Stainless Steel.....	DC-BAAA-8122405-S.....	\$25 pair
48-52 Door Handle Pads - Does Both Exterior Handles.....	DC-7C-8122428.....	\$4
53-60 Door Handle Pads - Set of 4 Pads For Both Exterior Handles.....	DC-BAAA-8122428.....	\$7



Vent Window Handles

48-50 Vent Window Handle - LH.....	DC-78-7022917.....	\$27
48-50 Vent Window Handle - RH.....	DC-78-7022916.....	\$27
51-52 Vent Window Handle - LH.....	DC-8M-7022917.....	\$27
51-52 Vent Window Handle - RH.....	DC-8M-7022916.....	\$27
53-55 Vent Window Handle - LH.....	DC-BAAA-8122917.....	\$25
53-55 Vent Window Handle - RH.....	DC-BAAA-8122916.....	\$25
56-60 Vent Window Handle - LH.....	DC-A9AZ-7022917-A.....	\$25
56-60 Vent Window Handle - RH.....	DC-A9AZ-7022916-A.....	\$25
51-60 Vent Window Handle Button Kit Only.....	DC-8A-7022920-S.....	\$5





Vent Window Parts

48-50 Vent Window Handle Shaft - LH or RH.....	DC-7C-7022938.....	\$16 each
51-55 Vent Window Handle Shaft - LH or RH.....	DC-01A-7022938.....	\$16 each
56-60 Vent Window Handle Shaft - LH.....	DC-8A-7022939-B.....	\$16
56-60 Vent Window Handle Shaft - RH.....	DC-8A-7022938-B.....	\$16
51-60 Vent Window Handle Button Kit.....	DC-8A-7022920-S.....	\$5
53-55 Vent Window Frame - LH - No Glass.....	ACP-FP-VW010A.....	\$99
53-55 Vent Window Frame - RH - No Glass.....	ACP-FP-VW010.....	\$99
53-55 Vent Frame Upper Pivot - Male - LH (BAAA-8121465-A).....	PMC-1146-ML.....	\$15
53-55 Vent Frame Upper Pivot - Male - RH (BAAA-8121464-A).....	PMC-1146-MR.....	\$15
53-55 Vent Window Lower Pivot Assembly - LH.....	PMC-1147-L.....	\$15
53-55 Vent Window Lower Pivot Assembly - RH.....	PMC-1147-R.....	\$15
53-56 Vent Window Lower Pivot - Stud Only - LH.....	DC-BAAA-8121408-L.....	\$20
53-56 Vent Window Lower Pivot - Stud Only - RH.....	DC-BAAA-8121408-R.....	\$20
56 Ford Vent Window Lower Pivot - LH or RH.....	DC-B6C-8121408.....	\$20 each
53-96 Vent Window Pivot Spring.....	DC-B5A-7022926-A.....	\$5 each

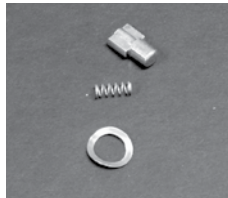

Door Hinges

32-56 Door Hinge Pin Puller.....	DC-TL-100.....	\$46
32-52 Door Hinge Pin - Steel.....	DC-B-7022840.....	\$3
32-52 Door Hinge Pin - Stainless Steel.....	DC-B-7022840-SS.....	\$4
48-52 Door Hinge Thread Plate & Bolt Kit (Repair Kit).....	MEF-7C-1166-KIT.....	\$59
53-56 Door Hinge - Fits LH/RH & Top/Bottom.....	ACP-FP-BD011.....	\$59 each
53-60 Door Hinge Bolt - OE Flange Bolt.....	DC-20327-S8.....	\$0.55 each
53-56 Door Hinge Cover - Steel Reproduction (Need 4 per truck).....	CMW-1178.....	\$9 each



Door Inspection Plate

53-56 Door Inspection Plate - Steel.....	CMW-2126-STL.....	\$55
53-56 Door Inspection Plate Gasket - Pair.....	PMC-2126-GSKT.....	\$19 pair

Door Locks & Parts

53-60 Door Lock Cylinder Retainer Clip.....	DC-B5A-7022023-A.....	\$5
53-60 Door lock installation kit: Lock link/lever w/spring + retainer.....	PMC-81136.....	\$19
53-60 Door Lock Link.....	DC-B4C-8121971-A.....	\$13
53-60 Door Lock Link Spring.....	PMC-1135.....	\$2.50
53-56 Door Latch Rubber Bumper.....	PMC-81085.....	\$3 pair
53-60 Door Lock Cylinders & 1 Key - LH & RH Matched Set.....	DC-B7A-7021984-PR.....	\$43
53-60 Lock Set - 2 Door Lock Cylinder's - 1 Ignition & 1 Key.....	DC-BAAA-7022050-S.....	\$55
53-60 Door Lock Cylinder Pads - Pair.....	DAL-8A-21985-70S.....	\$3
32-52 Door or Ignition Key - Anniversary - Blank.....	DC-APA-18316.....	\$12
48-52 Door or Ignition Key - Truck - Blank.....	DC-1A-3685-A.....	\$7
53-66 Door or Ignition Key - F100 & F250 - Blank.....	DC-BA-3685-A.....	\$6



» Door Parts

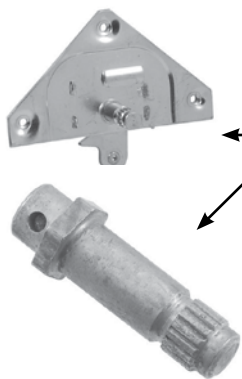

Door Handle Relay

53-56 Door Handle Relay - Shaft Assembly w/ Arm - LH or RH	OVL-53F-702411.....	\$45 each
53-56 Door Handle Relay - Shaft Assembly - NO Arm - LH or RH	DC-BAAA-8121818-R.....	\$45 each
53-56 Door Handle Shaft Repair - Use when splines are stripped	DC-BAAA-8121818-RK.....	\$16 each



*OVL-53F-702411
53-56 Ford Door Handle
Relay - Shaft Assembly w/
Arm - LH or RH*

Door Latches & Dovetail Assemblies

48-52 Female Dovetail Repair Kit	DAL-11A-702574-RK	\$8.50 each
48-52 Male Door Dovetail	DC-11A-7023006	\$9
53-55 Door Latch - LH	DAL-BAAA-21813-81A.....	\$69
53-55 Door Latch - RH	DAL-BAAA-21812-81A.....	\$69
56 Door Latch - LH	DAL-B6C-21813-81A.....	\$69
56 Door Latch - RH	DAL-B6C-21812-81A.....	\$69

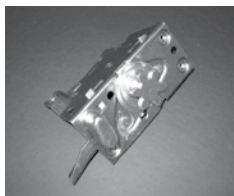

Altman Easy Latch Kit - Bear Claw

48-52 Altman Easy Latches - Steel - Bolt On	TRQ-AEL-FT4852	\$379
53-56 Altman Easy Latches - Steel - Bolt On	TRQ-AEL-FT5356	\$325

Complete kit to install Bear Claw type latches in your 48-56 Ford truck. Use your stock inside and outside door handles. Some trimming is required for installation.

Striker Plates

48-52 Door Striker Plate For Door Post (Fits LH or RH)	DC-7C-8122010.....	\$11 each
53-55 Door Striker Plate - LH	DC-BAAA-8122009-A	\$20
53-55 Door Striker Plate - RH	DC-BAAA-8122008-A	\$20
56 Door Striker Plate - LH	DC-B6C-8122009.....	\$20
56 Door Striker Plate - RH	DC-B6C-8122008.....	\$20
53-56 Striker Plate Shim - LH or RH	DC-B6C-8122058-A	\$3 each
53-67 Door Striker Screw / Bolt (Need 3 per door)	DC-353382-S.....	\$1 each



Complete Anti-Rattle Kits & Parts

Deluxe Anti-Rattle Kits contain 2 complete division bars, 4 anti-rattlers (window felts), 2 L-Shaped Glass Run Channel, Clips/Hardware.

48-52 Complete Anti-Rattle Kit - For Door Glass.....	DC-7C-8121460-CA.....	\$219
53-55 Complete Anti-Rattle Deluxe Kit - For Door Glass.....	DC-BAAA-8121460-CA.....	\$240
56 Complete Anti-Rattle Deluxe Kit - For Door Glass.....	DC-B6C-8121460-CA.....	\$219

Anti-Rattle & Door Channel Parts

48-52 Anti-Rattlers - Window Sweeps - Set of 4.....	DC-7C-8121452-SET.....	\$60/set
48-52 Division Bar - LH.....	DC-7C-8122297-CA.....	\$58
48-52 Division Bar - RH.....	DC-7C-8122296-CA.....	\$58
48-52 Door Glass Run - LH or RH (Need 2 per truck).....	DC-7C-8121555.....	\$38 each
53-55 Anti-Rattlers - Window Sweeps - Pair (Need 2 Pairs per truck).....	DC-BAAA-8121452-PR.....	\$33
53-55 Division Bar - LH.....	DC-BAAA-8122297-CA.....	\$52
53-55 Division Bar - RH.....	DC-BAAA-8122296-CA.....	\$52
53-55 Door Glass Run - LH or RH (Need 2 per truck).....	DC-B4C-8121554.....	\$53 each
56 Anti-Rattlers - Window Sweeps - Pair (Need 2 Pairs per truck).....	DC-B6C-8121452-PR.....	\$30
56 Division Bar - LH.....	DC-B6C-8122297-CA.....	\$50
56 Division Bar - RH.....	DC-B6C-8122296-CA.....	\$50
56 Door Glass Run - LH or RH (Need 2 per truck).....	DC-B6C-8121508-A.....	\$41 each
53-56 Lock Side Window Channel Holder - LH.....	CMW-3114-L.....	\$49
53-56 Lock Side Window Channel Holder - RH.....	CMW-3114-R.....	\$49

Mirrors

Door Edge Peep Mirror 4" - Fits LH or RH.....	UAP-C5001.....	\$25
Classic Style Exterior Mirror - LH.....	UAP-C5058L.....	\$27
Classic Style Exterior Mirror - RH.....	UAP-C5058R.....	\$27
32-52 Exterior Mirror Head - Polished Stainless Steel.....	UAP-B21030-2.....	\$22
48-52 Door Mirror - Arched Arm - Chrome - Hinge Mount - LH or RH.....	DC-48-18403.....	\$40
53-66 Door Mirror - Original Style fits LH or RH - Best Quality.....	DC-B6C-17696-S.....	\$67
53-66 Door Mirror - Chrome - Not Original.....	AMD-570-4553.....	\$56
53-66 Grommet For Door Mirror Arm (Rectangle).....	DAL-BAAA-17699-S.....	\$2
53-66 Mirror Head - Round for OEM type mirror.....	DC-BAAA-17696-H.....	\$25
53-66 Door Mirror Bullet Caps - Chrome - Pair.....	AMD-570-4553-1P.....	\$17 pair
53-66 Door Mirror Hole Plug.....	DC-352488-S.....	\$3
40-52 Rear View Mirror - Stainless Steel.....	DC-6A-17682-SS.....	\$59
53-55 Rear View Mirror - Stainless Steel.....	OVL-BAAA-17682-SS.....	\$59
56 Rear View Mirror - Chrome.....	OVL-B6C-17682-SS.....	\$55

GLASS

Ask Us About
Smoked Glass.
We're Looking For
a New Supplier.



Vent Window Glass

48-52 Vent Window Glass - Clear.....	AMD-560-4548-C.....	\$30
48-52 Vent Window Glass - Tinted.....	AMD-560-4548-T.....	\$30
53-55 Vent Window Glass - Clear.....	AMD-560-4553-C.....	\$30
53-55 Vent Window Glass - Tinted.....	AMD-560-4553-T.....	\$30
56 Vent Window Glass - Clear.....	AMD-560-4556-C.....	\$22
56 Vent Window Glass - Tinted.....	AMD-560-4556-T.....	\$22

Door Glass

48-52 Door Glass - Clear.....	AMD-550-4548-C.....	\$45
48-52 Door Glass - Tinted.....	AMD-550-4548-T.....	\$45
48-52 Complete 1 Pc Window Kit - For Both Doors.....	GH-4852F-1SW.....	\$459
53-55 Door Glass - Clear.....	AMD-550-4553-C.....	\$49
53-55 Door Glass - Tinted.....	AMD-550-4553-T.....	\$45
53-55 Complete 1 Pc Window Kit - For Both Doors.....	GH-5355F-1SW.....	\$569
56 Door Glass - Clear.....	AMD-550-4556-C.....	\$45
56 Door Glass - Tinted.....	AMD-550-4556-T.....	\$45
56 Complete 1 Pc Window Kit - For Both Doors.....	GH-56F-1SW.....	\$479

Rear Window Glass

48-50 Rear Window Glass - Clear.....	AMD-660-4548-C.....	\$52
48-50 Rear Window Glass - Tinted.....	AMD-660-4548-T.....	\$49
51-52 Rear Window - Clear.....	AMD-660-4551-C.....	\$59
51-52 Rear Window - Tinted.....	AMD-660-4551-T.....	\$55
53-56 Rear Small Window Glass- Clear.....	AMD-660-4553-C.....	\$69
53-56 Rear Small Window Glass - Tinted.....	AMD-660-4553-T.....	\$69
53-56 Big Rear Window Conversion Frame Kit.....	OVL-53F-704280-CONV.....	CALL

Big back window is special order and requires truck freight shipping - We will quote shipping

Windshield Glass (53-55 & 56 Call Us)

48-52 Windshield Glass - Clear.....	AMD-380-4556-C.....	\$190
48-52 Windshield Glass - Tinted.....	AMD-380-4556-T.....	\$190

Windshields are special order and require truck freight shipping - We will quote shipping

Accessories

Rope in Tool For Rubber Glass Seal Installation.....	AMD-TOOL-1.....	\$17
Glass Setting Tape.....	DC-8A-7021478.....	\$8

Weatherstrip - Cab Kits

48-50 Weatherstrip - Cab Kit - No Chrome (Includes Windshield, Rear Window, Door Seals)	DC-CAB48-A.....	\$109
51-52 Weatherstrip - Cab Kit - No Chrome..... (Includes Windshield, Rear Window, Door Seals)	DC-CAB51-A.....	\$109
51-52 Weatherstrip - Cab Kit - With Chrome Groove In Front Seal (Includes Windshield, Rear Window, Door Seals)	DC-CAB51-B.....	\$109
53-55 Weatherstrip - Cab Kit - Standard (Includes Windshield, Rear Window, Door Seals)	DC-CAB53-B.....	\$102
56 Weatherstrip - Cab Kit - Small Back Window - No Chrome Trim (Includes: Windshield, Small Rear Window, Door Seals)	DC-CAB56-A.....	\$110
56 Weatherstrip - Cab Kit - Small Back Window - With Chrome Groove In Front Seal..... (Includes: Windshield, Small Rear Window, Door Seals)	DC-CAB56-B.....	\$110
56 Weatherstrip - Cab Kit - Big Back Window - With Chrome Groove (Includes: Windshield, Big/Wrap-around Rear Window, Door Seals)	DC-CAB56-BB.....	\$115



Weatherstrip & Seals

42-56 Seal - Cowl Lacing (Lace) - OE Cloth Type.....	DC-21C-16740.....	\$18
42-60 Seal - Cowl Lacing (Lace) - Rubber - NOT Like OE Type.....	DC-B7C-16740.....	\$10
48-52 Seal - Cowl Vent (Gasket).....	DC-7C-8102330-A.....	\$12
53-56 Seal - Cowl Vent (Gasket).....	DC-BAAA-8102330-A.....	CALL
53-56 Seal - Side Cowl Vent.....	PMC-1937.....	\$8
48-52 Seal - Radiator Shroud to Hood - Lower.....	DC-7C-16614.....	\$5
48-52 Seal - Radiator Shroud to Hood - Upper.....	DC-8C-16614.....	\$6
53-56 Seal - Air Deflector to Top of Radiator Seal.....	DC-B3T-8349.....	\$7
53-56 Seal - Lower Radiator Grille Splash Pan.....	DC-B3T-8348-A.....	\$7
48-52 Weatherstrip - Windshield - No Groove for Chrome Trim.....	DC-7C-8103116-A.....	\$40
51-52 Weatherstrip - Windshield -With Groove for Chrome Trim.....	DC-1C-8103110.....	\$40
53-55 Weatherstrip - Windshield.....	DC-BAAA-8103110-A.....	\$40
56 Weatherstrip - Windshield - No Groove for Chrome Trim.....	DC-B6C-8103110-A.....	\$40
56 Weatherstrip - Windshield - With GROOVE for Chrome Trim.....	DC-B6C-8103110-B.....	\$40
48-52 Weatherstrip - Door Seal.....	DC-8C-8120530-PR.....	\$75 pair
53-55 Weatherstrip - Door Seal.....	DC-BAAA-8120530-PR.....	\$50 pair
56 Weatherstrip - Door Seal.....	DC-B6C-8120530-PR.....	\$50 pair
32-52 Lower Door Seals - Pair.....	DC-91C-8120706.....	\$10 pair
48-52 Lower Door Seal Retainer - Pair.....	DC-7C-8120712-PR.....	\$15 pair
53-56 Lower Door Seal Retainers - Pair.....	DC-BAAA-8120712-PR.....	\$20 pair



Weatherstrip & Seals

48-52 Weatherstrip - Vent Window Seal - Back Edge.....	DC-7C-8121450.....	\$5 pair
48-52 Weatherstrip - Vent Window Seal - Back Edge With Metal Backer - Pair	DC-7C-8121450-PR	\$20 pair
53-60 Weatherstrip - Vent Window Seal - Back Edge.....	DC-BAAA-8121450	\$5
53-55 Weatherstrip - Vent Window Seal - Back Edge With Metal Backer - Pair	DC-BAAA-8121450-PR.....	\$20 pair
56 Weatherstrip - Vent Window - Rear - Back Edge With Metal Backer - Pair.....	DC-B6C-8121450-PR.....	\$20 pair
48-52 Weatherstrip - Vent Window - Front.....	DC-7C-8121448-PR.....	\$70 pair
53-55 Weatherstrip - Vent Window - Front.....	DC-BAAA-8121448-PR	\$70 pair
56 Weatherstrip - Vent Window - Front.....	DC-B6C-8121448-PR.....	\$70 pair
48-50 Weatherstrip - Rear Window.....	DC-7C-8142084-A.....	\$23
51-52 Weatherstrip - Rear Window.....	DC-1C-8142084	\$25
53-56 Weatherstrip - Rear Window - Small Window	DC-BAAA-8142084	\$25
56 Weatherstrip - Rear Window - Wrap-Around - Big Wrap Around Window	DC-B6C-8142084-A	\$40
48-52 Weatherstrip - PANEL TRUCK Rear Door Seal - Pair	DC-8C-8243722-PR	\$85 pair
53-56 Weatherstrip - PANEL TRUCK Rear Door Seal - Pair	DC-BAAA-8243722-PR	\$74 pair

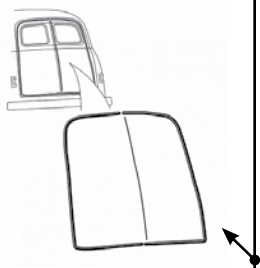

One Piece Door Window Kits

48-52 One Piece Door Window Kit..... GH-4852F-ISW..... \$459

Ford F1 One Piece Door Window Kits (For Both Doors) - Includes channels, glass runs, tempered glass, hardware and detailed installation instructions. Can be used with a power window kit or the manual stock lift. This item is oversized. Additional shipping may be required. Please specify glass color: clear or smoked (gray) when ordering. Tint (green) is no longer available.

Note: we do not include stock felt guide on lock side of door nor regulator; use the existing ones in your door.

53-55 One Piece Door Window Kit..... GH-5355F-ISW..... \$569

F100 One Piece Door Window Kits (For Both Doors) - channels, glass runs, curved glass and detailed instructions on how to install. Can be used with a power window kit (not included) or the manual stock window regulator. We leave the lift channel off for power window versions so you can position it correctly for your power window kit. We do recommend you use a heavy duty power window kit. Contact us if you need a power window kit. Please specify glass color: clear, tinted green or smoked (gray) when ordering.

Note: May take up to 3 weeks to build and ship. These kits are custom built as they are ordered.

56 One Piece Door Window Kit..... GH-56F-ISW..... \$479

Ford F100 One Piece Door Window Kits - Includes channels, glass runs, glass and detailed installation instructions. Can be used with a power window kit or the manual stock lift. No power window unit is included. Please contact us if you need a power window kit. We recommend a heavy duty power window kit with a strong motor. Please specify glass color: clear, tinted (green) or smoked (gray) when ordering.

Note: May take up to 3 weeks to build and ship. These kits are custom built as they are ordered.

Window Parts

For window handles and handle parts see pages 12-13.

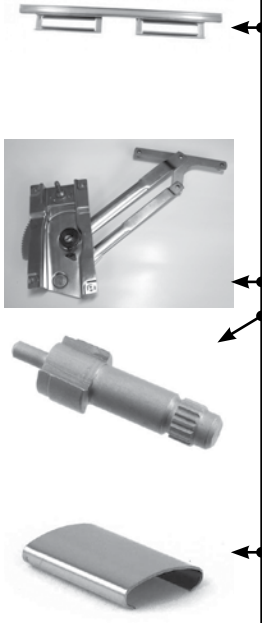

48-52 Window Lift Channel - LH or RH.....	DC-7C-8121462-A.....	\$22 each
53-55 Window Lift Channel - LH or RH.....	DC-B5C-8121458-A.....	\$25 each
56 Window Lift Channel - LH.....	DC-B6C-8121459-A.....	\$25
56 Window Lift Channel - RH.....	DC-B6C-8121458-A.....	\$25
48-52 Window Regulator - LH.....	DC-7C-8123201-A.....	\$75
48-52 Window Regulator - RH.....	DC-7C-8123200-A.....	\$75
53-55 Window Regulator - LH.....	DAL-BAAA-23201-81A.....	\$95
53-55 Window Regulator - RH.....	DAL-BAAA-23200-81A.....	\$95
53-55 Window Regulator Repair Shaft - Use for stripped shaft.....	DC-BAAA-8123205-S.....	\$16 each
56 Window Regulator - LH.....	OVL-56F-48105.....	\$89
56 Window Regulator - RH.....	OVL-56F-48106.....	\$89
56-60 Window Regulator Repair Shaft - Use for stripped shaft.....	DC-B6C-8123205-S.....	\$16 each
53-60 Regulator Roller Assembly.....	DC-BA-7023240-A.....	\$5.50 each
56 Custom Cab Window Trim Joint Clip - Stainless Steel.....	CMW-1218-RP.....	\$3
Glass Setting Tape - 3/64" Thick x 1 1/2" wide x 4' Long.....	DC-8A-7021478.....	\$8

**Buy Online @
www.CMWTrucks.com**



**Scan The QR Code With Your Mobile
Phone's Camera to go to our website**



**Our Website Can Be Very
Helpful In Building Your Truck**

Emblems & Chrome



Pad Sold Separately



*DC-BAAA-16638-S
Hood Emblem Pad*

48-50 & 52 Grille Letter Set - Chrome - "FORD"	DC-7C-8315-S.....	\$49.50
48-50 Cab Side Emblem - Chrome - "F1"	DC-8C-16605.....	\$28
51 Grille Emblem - Chrome - "V8"	DC-1RC-8259-A	\$52
52 Grille Emblem - Chrome - "V8"	DC-2C-16608-A	\$52
53 Grille Emblem - Chrome - "V8".....	DC-BAAA-8259-A.....	\$72
53 Grille Emblem Star - Chrome - " 6cyl "	DC-BAAA-8259-S.....	\$52
53 Grille Teeth - Set of 6 - Chrome With Install Template	DC-BAAA-8164-SET	\$229
53 Grille & Emblem Support Bracket - Stainless Steel	CMW-1210-53SS.....	\$29
54 Grille Emblem - Chrome - "V8".....	DC-B4C-8259	\$67
54 Grille Emblem Star - Chrome - " 6cyl "	DC-B4C-8259-S.....	\$52
54 Grille Hash Mark Set - Chrome - For Custom Cab Trucks.....	DC-B4C-8251-PR.....	\$199
54 Grille & Emblem Support Bracket - Stainless Steel	CMW-1210-54SS.....	\$29
55 Grille Emblem - Chrome - "V8".....	DC-B5C-8259	\$72
55 Grille Emblem Star - Chrome - " 6cyl "	DC-B5C-8259-S.....	\$52
55 Grille Gull Wing Mouldings - Chrome - Pair.....	DC-B5C-8419-PR.....	CALL
56 Grille Emblem - Chrome - "V8".....	DC-B6C-8259-A	\$70
56 Emblem to Grille Rubber Pad - "V8"	DC-B6C-8259-BRP.....	\$10
55-56 Door Emblem Set - "Custom Cab".....	DC-B5C-8125622-PR	\$45
55-56 Door Emblem Set Rubber Pad For "Custom Cab"	DC-B5C-8125622-BRP	\$13
48-50 Hood Side Moulding Set - No Clips	DC-7C-16720-S.....	\$139
48-50 Hood Side Molding Clip Set.....	DC-358158-SET	\$27
51-52 Hood Side Molding Clip Set.....	DC-357841-SET	\$8
53-56 Hood Emblem - "Ford-O-Matic"	DC-BF-7042527-A.....	\$32
53-56 Hood Emblem - "Overdrive".....	DC-BF-7042528-A.....	\$25
53-56 Main Hood Emblem - Ford With Gear & Thunderbolt-With Fasteners - NO Pad	DC-BAAA-16637-A.....	\$50
53-56 Hood Emblem Pad - FLAT	DC-BAAA-16638-S	\$3
53-56 Hood Emblem Pad - BEADED EDGE.....	DC-BAAA-16637-BRP.....	\$8
53-54 Hood Side Emblem Set - Chrome "Ford F100" - Pair.....	DC-BAAA-16721-PR.....	\$50 pair
53-54 Hood Side Emblem - Deluxe - Set With Chrome "Ford F100" & Boomerangs.....	DC-BAAA-16732-KIT	CALL
55 Hood Side Emblem Set - "Ford F100" - Chrome with red paint	DC-B5C-16721-PR.....	\$88
56 Hood Side Emblem Set - "Ford F100" - Chrome with red paint	DC-B6C-16720-PR.....	\$100
56 Hood Side Emblem Set - "Ford F100" - Chrome - NO paint	DC-B6C-16720-CPR	\$88
56 Hood Side Emblem Pad - Rubber - Pair.....	DC-B6C-16720-BRP	\$22
56 Custom Cab Window Trim Joint Clip - Stainless Steel	CMW-1218-RP	\$3
"Ford" Script Logo - Chrome - Fits Shield Taillights.....	UAP-S1018	\$7



53-55 Door & Dash Trim Set - Stainless Steel - With Install Clips..... DC-BAAA-8120960-S \$159
 53-56 Door Handle Shield Set - Polished Stainless Steel..... DC-BAAA-8122405-S..... \$29

56 Stainless Trim For Outside Door Around Window Opening - With Clips DC-B6C-8120910-PR \$169 pair
 56 Door Trim installation clips - Set of 22 DC-B6C-8120915-S \$15 set



Grille
 48-55 Headlight Bezel - Polished Stainless Steel..... DC-FAD-13045..... \$25
 56 Headlight Bezel..... OVL-B6C-13064-A..... CALL



48-55 Headlight Bucket - LH or RH..... DC-1C-13008-A..... \$75
 56 Headlight Bucket - LH or RH..... DC-B6C-13008-A \$85



42-56 Gasket - Headlight Bucket to Grille - Need 2 Per Truck..... DC-11A-13044 \$4 each
 40-66 Round Headlight Headlamp Retainer Ring - Stainless Steel - Like OEM DAL-01A-13018-SS \$12

48-50 Lower Air Deflector (Replaces Ford part# 7HC-8240)..... AMD-120-4548-1..... \$55
 48-50 Lower Grille Panel Or Valance AMD-115-4548..... \$169
 48-50 Upper Grille Panel..... AMD-130-4548-1..... \$179

51-52 Lower Grille Panel Or Valance..... AMD-115-4551..... \$249
 51-52 Upper Grille Panel..... AMD-130-4551-1..... \$199

48-50 Grill Shell..... DC-7C-8204-B..... CALL
 48-50 Grill Shell - With Holes For Grill Bars..... DAL-7C-8200-WH..... CALL

48-50 Grille Assembly - Black - No Bar Holes - With Crank Cutout..... LM-49-8897 CALL
 48-50 Grille Assembly - Black - With Bar Holes & Crank Cutout..... LM-49-8899 CALL
 48-50 Grille Assembly - Chrome - No Bar Holes - With Crank Cutout..... LM-49-8898 CALL

48-50 Grille Trim Set - Polished Stainless Steel - No Crank Hole..... DC-7C-8200-GBK-WOC..... \$199
 48-50 Grille Trim Set - Polished Stainless Steel - With Crank Hole..... DC-7C-8200-GBK..... \$199

53 Grille & Emblem Support Bracket - Stainless Steel..... CMW-1210-53SS..... \$29
 54 Grille & Emblem Support Bracket - Stainless Steel..... CMW-1210-54SS..... \$29
 56 Vertical Grille Support - Steel..... DAL-B6C-16864-A..... \$19
 56 Vertical Grille Support - Stainless Steel..... DAL-B6C-16864-PSS..... \$29
 Installs behind the grille in the center of the radiator. Bolts to the lower valance.

56 Truck Grille - Chrome..... AMD-150-4556..... \$719



» Front Fenders



Front Fenders ***Fenders ship truck freight - We will quote shipping***

48-50 Front Fender - F1 - LH - Steel.....	AMD-200-4548-L.....	\$699
48-50 Front Fender - F1 - RH - Steel.....	AMD-200-4548-R.....	\$699
48-50 Front Fender Extension - LH - Steel.....	AMD-210-4548-L.....	\$135
48-50 Front Fender Extension - RH - Steel.....	AMD-210-4548-R.....	\$135
51-52 Front Fender - F1 - LH - Steel.....	AMD-200-4551-L.....	\$699
51-52 Front Fender - F1 - RH - Steel.....	AMD-200-4551-R.....	\$699
51-52 Front Fender Extension - LH - Steel.....	AMD-210-4551-L.....	\$159
51-52 Front Fender Extension - RH - Steel.....	AMD-210-4551-R.....	\$159
53-56 Front Fender - LH - Steel.....	AMD-200-4553-L.....	\$349
53-56 Front Fender - RH - Steel.....	AMD-200-4553-R.....	\$349
53-56 Front Fender Brace - LH - Steel.....	DAL-BAAA-16011-A.....	\$15
53-56 Front Fender Brace - RH - Steel.....	DAL-BAAA-16010-A.....	\$15
53-56 Front Fender Brace - LH - Polished Stainless Steel.....	DAL-BAAA-16011-PSS.....	\$20
53-56 Front Fender Brace - RH - Polished Stainless Steel.....	DAL-BAAA-16010-PSS.....	\$20



Inner Fenders

48-50 Inner Fender - F1/F2 - LH.....	AMD-250-4548-L.....	\$179
48-50 Inner Fender - F1/F2 - RH.....	AMD-250-4548-R.....	\$179
51-52 Inner Fender - F1/F2 - LH.....	AMD-250-4551-L.....	\$169
51-52 Inner Fender - F1/F2 - RH.....	AMD-250-4551-R.....	\$169
53-56 Inner Fender - LH - OEM Type.....	DAL-BAAD-16055-A.....	\$199
53-56 Inner Fender - RH - OEM Type.....	DAL-BAAD-16054-A.....	\$199



Custom Inner Fenders

53-56 Inner Fenders - Custom Steel - Pair.....	CMW-0001-PR.....	\$239
--	------------------	-------

Fender Hardware

48-52 Fender to Cowl Seals - Pair.....	DC-7C-16068.....	\$15
53-56 Fender to Cowl Bracket - LH.....	AMD-261-4553-L.....	\$32
53-56 Fender to Cowl Bracket - RH.....	AMD-261-4553-R.....	\$32
53-56 Fender to Cowl Seal - Sold as a Pair.....	DC-BAAA-16126.....	\$15 pair
53-56 Fender to Cab Reinforcement Bracket - LH.....	CMW-1562.....	Coming Soon
53-56 Fender to Cab Reinforcement Bracket - RH.....	CMW-1563.....	\$39
53-56 Bolt Kit For Front Sheet Metal - Button Head Stainless Steel.....	CMW-1051-SS.....	\$49
53-56 Bolt Kit For Front Sheet Metal - Hex Head Stainless Steel.....	CMW-1050-SS.....	\$49
48-52 Front Inner Splash Apron to Fender Bolts - Set of 10.....	DC-91A-16084-S10.....	\$10
48-52 Front Inner Splash Apron to Frame Bumper - Set.....	DC-7C-16754-B.....	\$4
Custom 1" Diameter Stainless Steel Recessed Finish Washer, Bolt & Nut - Set of 12.....	CMW-5000-SS.....	\$24





Body Bolt Kit

This kit includes almost all of the fasteners you need to assemble your 53-56 Ford truck from the cab forward.

- 53-56 Body Bolt Kit - Button Head - Raw Stainless Steel - No Bed Fasteners..... TRU-23-3100\$299
- 53-56 Body Bolt Kit - Button Head - Polished Stainless Steel - No Bed Fasteners..... TRU-24-3100\$418
- 53-56 Body Bolt Kit - Hex Head - Raw Stainless Steel - No Bed Fasteners..... TRU-2-3100\$289
- 53-56 Body Bolt Kit - Hex Head - Polished Stainless Steel - No Bed Fasteners..... TRU-22-3100\$418

Air Deflectors & Radiator Core Support

48-50 Upper Grille Panel	AMD-130-4548-1	\$179
51-52 Upper Grille Panel	AMD-130-4551-1	\$199
48-50 Lower Air Deflector	AMD-120-4548-1	\$55
51-52 Lower Air Deflector	AMD-X120-4551	\$49
48-52 Upper Air Deflector - LH - Steel	AMD-151-4548-L	\$26
48-52 Upper Air Deflector - RH - Steel	AMD-151-4548-R	\$26
51-52 Headlight Support - LH	AMD-151-4551-L	\$40
51-52 Headlight Support - RH	AMD-151-4551-R	\$40
53-55 Air Deflector - LH - Steel	AMD-151-4553-L	\$99
53-55 Air Deflector - RH - Steel	AMD-151-4553-R	\$99
56 Air Deflector - LH - Steel	AMD-151-4556-L	\$99
56 Air Deflector - RH - Steel	AMD-151-4556-R	\$99
1956 Air deflectors are dished out to make room for the headlight bucket. The headlight bucket sits deeper in the 56 grille.		
53-56 Fender to Radiator Alignment Brackets - Set - Polished Stainless Steel	PMC-2056	CALL
53-56 Fender to Radiator Alignment Rods - Polished Stainless Steel	CMW-2054-PS	\$89 each
53-56 Radiator Core Support - With Braces	DAL-B3C-16138-B	\$199
53-56 Air Deflector to Top of Radiator Seal	DC-B3T-8349	\$7
53-55 Radiator Support Mount Kit	DC-BAAA-8125-S	\$22
56 Radiator Support Mount Kit	DC-B6C-8125-S	\$20

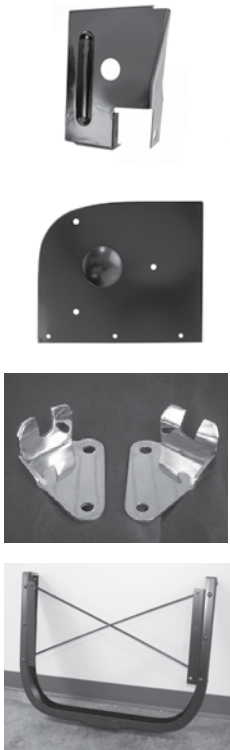

Hood Parts

	48-52 Hood Hinge Bracket - LH.....	DC-7C-16797.....	\$55
	48-52 Hood Hinge Bracket - RH.....	DC-7C-16796.....	\$55
	48-52 Hood Hinge Support Arm - LH.....	DC-7C-16803-B.....	\$89
	48-52 Hood Hinge Support Arm - RH.....	DC-7C-16802-B.....	\$89
	48-52 Hood Hinge to Hood - 4 Bolt Set.....	DC-91A-16798-S.....	\$15
	53-55 Hood Hinge - LH.....	ACP-FP-CAS-3A.....	\$69
	53-55 Hood Hinge - RH.....	ACP-FP-CAS-3.....	\$69
	53-55 Hood Hinge Bolt - Mounts Hinge to Hood - Need 4 Per Truck.....	DC-8A-16798-S.....	\$3 each
	53-56 Hood Hinge Base Bolt "D" Washer.....	PMC-82013-W.....	\$2.25 each
	53-56 Hood Hinge Spring Only - LH or RH.....	DAL-BF-16812-A.....	\$20 each
	56 Hood Hinge - LH.....	ACP-FP-CAS-4A.....	\$69
	56 Hood Hinge - RH.....	ACP-FP-CAS-4.....	\$69
	56 Hood Hinge Bolt - Mounts Hinge to Hood - Need 4 Per Truck.....	DC-B6C-16798-S.....	\$3 each
	48-52 Hood Bumper Set - Rubber.....	DC-7C-16761.....	\$8
	53-56 Hood Bumper Set - Rubber.....	DC-BAAA-16761.....	\$9
	53-56 Hood - Reproduction in Steel - Fits 56 Hinges/Bolts (Truck Freight).....	OVL-53F-16730.....	CALL
	53-56 Hood Locking Panel.....	DAL-B5C-16717-A.....	\$169
	53-56 Hood Alignment Rods - Set - Polished Stainless Steel.....	PMC-2050-PS.....	CALL



Hood Latch

	53-56 Hood Latch - Altman Easy Hood Latch Kit.....	TRQ-AEL-FT5356-HOOD.....	\$224
	53-56 Hood Latch Assembly - Stainless Steel (Return spring not included).....	CMW-2017-SS.....	\$65
	53-56 Hood Latch Assembly - Polished Stainless Steel.....	PMC-2017-PS.....	N/A
	53-56 Hood Latch Return Spring.....	DC-BAAA-16921-A.....	\$1
	48-50 Hood Dowel - F1 to F6 - Zinc Plated.....	DC-7C-16929.....	\$22
	51-52 Hood Locking Plate Guide Dowel - F1 to F6 - Zinc Plated.....	DC-1C-16929.....	\$22
	53-56 Hood Dowel - Steel.....	PMC-2013.....	\$27
	53-56 Hood Dowel - Stainless Steel.....	CMW-4000-SS.....	\$18
	53-56 Hood Dowel - Polished Stainless Steel.....	CMW-4000-PSS.....	\$28
	53-56 Hood Dowel Nuts - SS (2).....	CMW-1090.....	\$2.75
	48-56 Hood Dowel Spring - Steel.....	DC-7C-16925.....	\$8
	48-56 Hood Dowel Spring - Stainless.....	CMW-7C-16925-SS.....	\$12
	48-56 Hood Dowel Spring - Polished Stainless Steel.....	CMW-7C-16925-PS.....	CALL
	48-56 Hood Dowel Spring Retainer Washer - Plain Steel.....	CMW-2013-W-STL.....	\$8
	48-56 Hood Dowel Spring Retainer Washer - Stainless Steel.....	CMW-2013-W-SS.....	\$9
	48-56 Hood Dowel Spring Retainer Washer - Polished Stainless Steel.....	CMW-2013-W-PSS.....	\$11



Hood Latch (continued)

48-50 Hood Safety Catch Spring - F1 to F6	DC-7C-16862.....	\$6.50
51-52 Hood Locking Trigger Spring - F1 to F6.....	DC-1C-16921.....	\$5
51-52 Hood Safety Catch - F1 to F6.....	DC-1C-16896.....	\$16
51-52 Hood Safety Catch Bracket & Spring Kit - F1 to F6	DC-16980-KIT.....	\$20
53-56 Hood Safety Catch - Stainless Steel.....	PMC-2016-SS.....	\$49
53-56 Hood Safety Catch - Polished Stainless Steel.....	PMC-2016-PS.....	CALL
48-50 Hood Front Opening Chrome Ornaments - F1 to F6 - Chrome.....	DC-7C-16608-PR.....	\$150



Reverse Hood Flip Kits

53-56 Reverse Flip Hood Tilt Kit - Steel.....	CPP-5356MMB-P.....	\$399
53-56 Reverse Flip Hood Tilt Kit - Stainless Steel.....	CPP-5356MMB-C.....	\$516
53-56 No Limit Reverse Flip Hood Tilt Kit	NOL-FTHK.....	\$525
53-56 Safety Latch Hole Cover on the Hood Latch Panel - Polished Stainless Steel.....	CMW-2339-CV.....	\$8



Radiator & Core Support

48-52 Radiator Support to Frame Pad.....	DC-8C-8124-A.....	\$3
48-52 Radiator Support to Frame Pad & Bolt Kit	DC-8C-8125-S.....	\$16
53-55 Radiator Support Mount Kit	DC-BAAA-8125-S.....	\$22
56 Radiator Support Mount Kit	DC-B6C-8125-S.....	\$22
48-50 Front Core Support	AMD-350-4548	\$349
51-52 Front Core Support.....	AMD-50-4551	\$329
53-56 Radiator Core Support - With Braces (DAL-B3C-16138-B).....	AMD-X350-4553.....	\$199
38-51 Radiator Cap - 4 lb.....	DC-41A-8100	\$15
52-56 Radiator Cap - 4 lb. - NO Pressure Relief Valve	DC-1T-8100-A.....	\$12
56 Water Temperature Sending Unit - 12 volt.....	DC-B6C-10884.....	\$49
48-52 Seal - Lower Radiator Grille Splash Pan to Radiator Seal.....	DC-7C-8348-A.....	\$4
48-52 Seal - Front Fender Skirt Flange to Radiator Grille Gasket.....	DC-7C-16086.....	\$10 Pair
48-52 Seal - Radiator Shroud to Hood - Lower.....	DC-7C-16614	\$5
48-52 Seal - Radiator Shroud to Hood - Upper - Need 2 Per Truck.....	DC-8C-16614.....	\$6
53-56 Seal - Lower Radiator to Valance.....	DC-B3T-8348-A.....	\$7
53-56 Seal - Air Deflector to Top of Radiator	DC-B3T-8349.....	\$7
53-56 Front of Hood to Upper Radiator Seal Metal Retainer (Track).....	DC-BAAA-16771.....	CALL
53-56 Seal - Hood to Upper Radiator	DC-BAAA-16770-A	\$8
53-56 Seal - Lower Radiator Grille Splash Pan.....	DC-B3T-8348-A.....	\$7



Body

» Patch Panels



Patch Panels - Rear of Cab

48-52 Rear Cab Corner - LH.....	AMD-480-4548-L.....	\$22
48-52 Rear Cab Corner - RH.....	AMD-480-4548-R.....	\$22
53-56 Rear Cab Corner - Outer - LH.....	AMD-480-4553-L.....	\$37
53-56 Rear Cab Corner - Outer - RH.....	AMD-480-4553-R.....	\$37
53-56 Cab Corner - LH - Inner Rear.....	AMD-481-4548-1L.....	\$64
53-56 Cab Corner - RH - Inner Rear.....	AMD-481-4548-1R.....	\$64
53-55 Fuel Neck Filler Metal Patch Piece.....	CMW-1650.....	\$17
56 Fuel Neck Filler Hole Patch Piece.....	CMW-1650-56.....	\$15
53-56 Door Pillar - Rear Lower - LH.....	PMC-7715-L.....	CALL
53-56 Door Pillar - Rear Lower - RH.....	PMC-7715-R.....	CALL
53-56 Rear Cab Mount Base Plate - LH or Right.....	CMW-0738.....	\$19 each
53-56 Rear Cab Mount Base Bracket - LH.....	AMD-425-4553-L.....	\$23
53-56 Rear Cab Mount Base Bracket - RH.....	AMD-425-4553-R.....	\$23

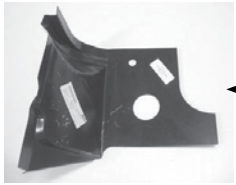

Patch panels Diagram

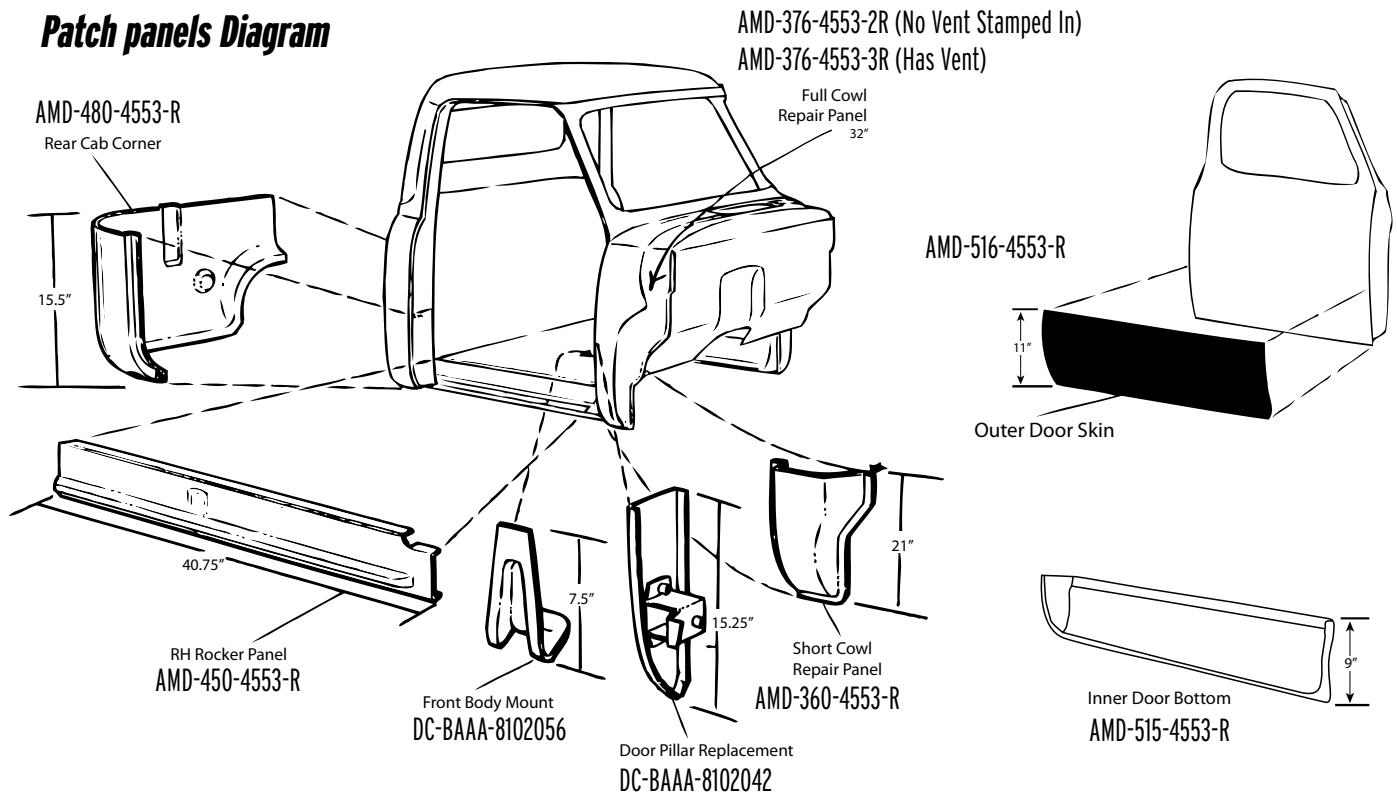

» Patch Panels



Firewall & Toe Board

48-52 Firewall Assembly.....	UAP-110440.....	CALL
53-56 Firewall & Toe Board - LH.....	AMD-370-4553-1L.....	\$119
53-56 Firewall & Toe Board - RH.....	AMD-370-4553-1R.....	\$119

****Above are oversized and may require extra shipping****

Patch Panels - Floor & Rocker



53-56 Floor Plates Around Steering Column No Column Hole - With Brake & Clutch Punch Out - 2 Piece.	CMW-4668-5356B.....	\$19
53-56 Floor Plates Around Steering Column Stock Steering Column Hole - With Brake & Clutch Punch Out - 2 Piece.	CMW-4668-5356.....	\$19



53-56 Seal - Steering Column to Floor - Column Shift - 3 pc Kit - OE Type.....	DC-BAAA-3513.....	\$8
53-56 Seal - Steering Column to Floor - Floor Shift - 3 pc Kit - OE Type.....	DC-BAAA-3513-A.....	\$8
53-56 Dimmer Switch Floor Plate - Steel.....	CMW-2914-FP.....	\$16
48-52 Floor Repair Panel - LH - USA Made.....	MEF-7C-811106-L.....	\$89
48-52 Floor Repair Panel - RH - USA Made.....	MEF-7C-811106-R.....	\$89
53-55 Floor Pan - Front - LH - USA Made.....	MEF-B6C-811106-S-L.....	\$89
53-55 Floor Pan - Front RH - w/Battery Hole - USA Made.....	MEF-B6C-811106-S-R.....	\$89
56 Floor Pan - Front LH - USA Made.....	MEF-B6C-811106-S-L.....	\$89
56 Floor Pan - Front RH - w/Battery Hole - USA Made.....	MEF-B6C-811106-S-R.....	\$89



53-56 Floor Pan - Rear.....	AMD-410-4553-1.....	\$232
53-55 Cab Floor Sending Unit Inspection Cover.....	CMW-2133.....	\$15
53-56 Cab Floor Brace - fits LH or RH.....	AMD-428-4553-1.....	\$27
53-56 Cab Floor Center Brace.....	CMW-1007.....	\$26



48-52 Rocker Panels - PR.....	DC-8C-8110110-PR.....	\$50
53-56 Rocker Panel - LH.....	AMD-450-4553-L.....	\$49
53-56 Rocker Panel - RH.....	AMD-450-4553-R.....	\$49
48-52 Transmission Floor Cover - USA Made.....	MEF-7C-8112108-ST.....	\$99
53-56 Transmission Hole Cover.....	AMD-415-4553-1.....	\$59

**Scan The QR Code
With Your Mobile Phone's Camera
to go to our website**



» Patch Panels



DC-BAAA-8102042
Lower Door Pillar
Replacement



Patch Panels - Front Cab Corner

48-52 Cowl Repair Panel - Front - LH.....	AMD-X376-4548-1L.....	\$69
48-52 Cowl Repair Panel - Front - RH.....	AMD-X376-4548-1R.....	\$69
48-52 Complete Cowl Repair Panel - LH.....	OVL-7C-8102055-FL.....	\$149
48-52 Complete Cowl Repair Panel - RH.....	OVL-7C-8102054-FR.....	\$149
53-56 Side Cowl Vent Block Off Plate (Plastic).....	PMC-1938.....	\$36
53-56 Cowl Repair Panel - complete LH.....	AMD-376-4553-2L.....	\$59
53-56 Cowl Repair Panel - NO Vent - complete RH.....	AMD-376-4553-2R.....	\$59
53-56 Cowl Repair Panel - With Vent - complete RH.....	AMD-376-4553-3R.....	\$65
53-56 Cowl Repair Panel - Outer Lower LH - 21" Tall.....	AMD-360-4553-L.....	\$40
53-56 Cowl Repair Panel - Outer Lower RH - 21" Tall.....	AMD-360-4553-R.....	\$40
53-56 Cowl Panel Lower Inspection Hole Cover.....	CMW-1020.....	\$7.75 each
53-56 Cab Repair Triangle Gusset - LH.....	CMW-7716-L.....	\$28
53-56 Cab Repair Triangle Gusset - RH.....	CMW-7716-R.....	\$28
53-56 Front Body Mount - LH.....	DC-BAAA-8102057.....	\$30
53-56 Front Body Mount - RH.....	DC-BAAA-8102056.....	\$30
53-56 Lower Door Pillar Replacement Front - LH.....	DC-BAAA-8102043.....	\$55
53-56 Lower Door Pillar Replacement Front- RH.....	DC-BAAA-8102042.....	\$55
53-56 Fender to Cab Reinforcement Bracket - LH.....	CMW-1562.....	COMING SOON
53-56 Fender to Cab Reinforcement Bracket - RH.....	CMW-1563.....	\$39
53-56 Cab Repair Triangle Gusset - LH.....	CMW-7716-L.....	\$28
53-56 Cab Repair Triangle Gusset - RH.....	CMW-7716-R.....	\$28



AMD-302-4553-2
Hood Front Edge Repair Panel

Hood Patch Panels

53-56 Hood Front Inner Reinforcement Patch Panel.....	AMD-302-4553-1.....	\$85
53-56 Hood Front Edge Repair Panel - Outer.....	AMD-302-4553-2.....	\$79

Door Patch Panels

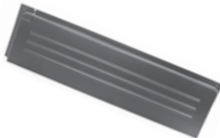

48-52 Door Skin - Lower LH	AMD-516-4548-L	\$59
48-52 Door Skin - Lower RH	AMD-516-4548-R	\$59
53-56 Door Skin - Lower LH	AMD-516-4553-L	\$49
53-56 Door Skin - Lower RH	AMD-516-4553-R	\$49
48-50 Inner Door Bottom - LH	AMD-515-4548-L	\$65
48-50 Inner Door Bottom - RH	AMD-515-4548-R	\$65
51-52 Inner Door Bottom - LH	AMD-515-4551-L	\$65
51-52 Inner Door Bottom - RH	AMD-515-4551-R	\$65
53-56 Inner Door Bottom - LH	AMD-515-4553-L	\$55
53-56 Inner Door Bottom - RH	AMD-515-4553-R	\$55
53-55 Door Shell - LH - reproduction	OVL-53F-702360	CALL
53-55 Door Shell - RH - reproduction	OVL-53F-702361	CALL
***Door shells must ship in a crate. Ask for crate and truck freight charges.		
48-52 Lower Door Seal Retainer - Pair	DC-7C-8120712-PR	\$15 pair
53-56 Lower Door Seal Retainers - Pair	DC-BAAA-8120712-PR	\$20 pair



AMD-515-4553-R
Inner Door Bottom



Rear Fender Patch Panels

53-79 Rear Fender Repair Panel - LH - Fixes Lower Front	AMD-204-4553-L	\$33
53-79 Rear Fender Repair Panel - RH - Fixes Lower Front	AMD-204-4553-R	\$33
Above fixes area where running board bolts to rear fender. Inside piece of metal also included (welded on)		

Body Bolt Kit



53-56 Body Bolt Kit - Hex Head - Raw Stainless Steel	TRU-2-3100	\$289
53-56 Body Bolt Kit - Hex Head - Polished Stainless Steel	TRU-22-3100	\$418
53-56 Body Bolt Kit - Button Head - Raw Stainless Steel	TRU-23-3100	\$299
53-56 Body Bolt Kit - Button Head - Polished Stainless Steel	TRU-24-3100	\$418

This kit includes almost all of the fasteners you need to assemble your 53-56 Ford truck from the cab forward.

*Does not include cab mounting bolts

- | | | | |
|-------------------|---------------------------|------------------------|--------------------------------|
| • Battery Box Kit | • Firewall Kit | • Hood Hinge Kit | • Seat Mounting Kit |
| • Bed Strip Kit | • Fresh Air Vent Kit | • Hood Latch Kit | • Splash Guard Kit |
| • Bumper Kit | • Front Bed Panel Kit | • Interior Kit | • Tailgate Hinges |
| • Cowl Vent Kit | • Front Fender Braces Kit | • Radiator Support Kit | • Tail Lights & Lic. Plate Kit |
| • Door Hinges Kit | • Front/Inner Fender Kit | • Rear Fender Kit | |
| • Door Jams Kit | • Hood Brace Kit | • Running Board Kit | |

» Valance & Running Boards



Front Valance (Splash Apron)

48-52 Front Inner Splash Apron to Fender Bolts - Set of 10	DC-91A-16084-S10	\$10
48-50 Lower Air Deflector (Replaces Ford part# 7HC-8240).....	AMD-120-4548-1.....	\$55
48-50 Lower Valance/Grille Panel.....	AMD-115-4548.....	\$169
51-52 Lower Valance/Grille Panel.....	AMD-115-4551.....	\$249
53 Splash Apron/Valance - Steel	AMD-115-4553.....	\$199
54 Splash Apron/Valance - Steel	AMD-115-4554.....	\$209
55-56 Splash Apron/Valance - Steel	AMD-115-4555.....	\$190

Front Roll Pan (Splash Apron)

53 Splash Apron/Valance - Steel	AMD-115-4553-1.....	\$255
54 Splash Apron/Valance - Steel	AMD-115-4554-1.....	\$252
55-56 Splash Apron/Valance - Steel	AMD-115-4555-1.....	\$210

Eliminate your front bumper and smooth out the front of your truck.

Front Hardware

53-56 Front Sheet Metal Bolt Kit - Button Head - Stainless Steel.....	CMW-1051-SS	\$49
53-56 Front Sheet Metal Bolt Kit - Hex Head - Stainless Steel.....	CMW-1050-SS	\$49

Running Boards

48-52 Running Board - LH - OE - Steel.....	AMD-722-4548-L.....	\$350
48-52 Running Board - RH - OE - Steel.....	AMD-722-4548-R.....	\$350
48-52 Running Board Set - OE - Steel.....	RVA-8C-16450-S.....	\$749 pair
48-52 Smooth Running Boards - Steel.....	SMF-7C-16450-PR-SM.....	CALL
53-56 Running Board - LH - OE - Steel - USA Made.....	DC-BAAA-16451-B	\$300
53-56 Running Board - RH - OE - Steel - USA Made.....	DC-BAAA-16450-B	\$300
53-56 Running Board Set - OE - Steel - USA Made	DC-BAAA-16450-PR.....	\$560
53-56 Smooth Running Boards - Steel - Truck - Import.....	DAL-BAAA-16450/1-SM	CALL
53-56 Smooth Running Board Set - Steel - Short Bed Only - Made in USA	CMW-BAAA-16450-SM	\$650 pair

53-56 Adjustable Running Board Bracket (4 Per Truck - Fix Alignment)..... **CMW-0342..... \$99 each**

53-56 Running Board Side Panel - LH.....	PMC-0332-L	\$45
53-56 Running Board Side Panel - RH	PMC-0332-R.....	\$45
53-56 Running Board Step Plate - With Ford Pickup Crest - Aluminum.....	DC-BAAA-16400.....	\$99.95
53-55 Cab Skirt Channel - Holds the Running Board to Cab Seal.....	DC-BAAA-8110112-PR.....	\$20 pair
53-55 Bottom of Cab to Running Board Seal (skirt) - Pickup Only	DC-BAAA-16540-A.....	\$20
56 Bottom of Cab to Running Board Seal (skirt) - Pickup only	DC-B6C-16540.....	\$15
53 - 56 Ford Panel Truck Running Board Seal - PANEL TRUCK ONLY	DC-BAAA-16540-C.....	\$25

48-52 Running Board Mount Kit - Bolts/Nuts/Washers.....	DC-7C-16455-S.....	\$15
48-52 Running Board Mount Kit - Bolts/Nuts/Washers - Stainless Steel.....	CMW-2000.....	\$9
53-56 Running Board to Fender - Rubber Spacers/Bolts/Nuts - Pair.....	DC-BAAA-16460-S	\$5
53-56 Running Board Mount Kit - Bolts/Nuts/Washers, 2 Rubber - Steel.....	CMW-2002.....	\$17
53-56 Running Board Mount Kit - Bolts/Nuts/Washers, 2 Rubber - Stainless Steel.....	CMW-2001.....	\$20

*Some running boards may require extra shipping and/or longer delivery time due to being individually made upon ordering.

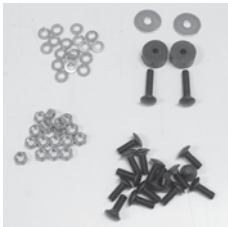

Master Cylinder - OE Type



39-52 Master Cylinder - F1 Only.....	DC-91A-2140.....	\$78
53-56 Master Cylinder - F100 2WD.....	DC-B3C-2140-A.....	\$99
39-56 Master Cylinder Repair Kit.....	DC-91A-2004.....	\$34
48-52 Master Cylinder Cap Gasket.....	DC-91A-2167.....	\$1
53-62 Master Cylinder Cap Gasket.....	DC-8M-2167.....	\$2
39-56 Master Cylinder Push Rod.....	DC-91A-2143.....	\$17.50
39-52 Master Cylinder Floor Cover Plate.....	DC-91A-7011136.....	\$10
53-56 Master Cylinder Floor Cover Plate.....	DC-BAAA-8111136.....	\$16
48-56 Master Cylinder Outlet Block - 3 Ports.....	DC-8C-2076.....	\$25
48-56 Master Cylinder Outlet Block Bolt.....	DC-91A-2077.....	\$5
48-56 Copper Washer - Front of Master Cylinder Outlet Block.....	DC-91A-2152.....	\$1
48-56 Copper Washer - Rear of Master Cylinder Outlet Block.....	DC-91A-2151.....	\$1
39-66 Brake Light Switch.....	DC-01A-13480.....	\$8

Wheel Cylinder - OE Type



48-60 Wheel Cylinder - Front - LH - 2WD.....	RAY-WC9090.....	\$17
48-60 Wheel Cylinder - Front - RH - 2WD.....	RAY-WC9091.....	\$17
48-54 Wheel Cylinder - Rear - LH.....	RAY-WC9025.....	\$17
48-54 Wheel Cylinder - Rear - RH.....	RAY-WC9026.....	\$17
55-75 Wheel Cylinder - Rear - LH.....	CEN-13461006.....	\$17
55-72 Wheel Cylinder - Rear - RH.....	CEN-13461007.....	\$17
48-67 Wheel Cylinder Repair Kit - Front - F1/F100.....	DC-A8C-2221.....	\$9
55-74 (-63) Wheel Cylinder Repair Kit - Rear - F100.....	DC-8A-2128.....	\$9

Drums

48-67 Brake Drum - Rear.....	CMW-1126.....	\$79 each
48-52 Brake Drum - Front.....	DC-8C-1125.....	\$139 each
53-63 Brake Drum - Front.....	DC-TAAA-1125-A.....	\$139 each

Gas, Brake & Clutch Pedal Pads & Pedal Arms



41-56 Pedal Pad - Brake or Clutch - OE Style.....	DC-11A-2454.....	\$11 each
40-52 Brake Pedal Return Spring.....	DC-01T-2472.....	\$4
53-56 Brake Pedal Return Spring.....	DC-TAAA-2472-A.....	\$5
42-52 Brake Pedal Arm to Master Cylinder Bolt.....	DC-21C-2462-A.....	CALL
48-56 Brake & Clutch Pedal Arm Bumpers (Rubber).....	DC-7C-2473.....	\$6 pair
48-52 Brake & Clutch Pedal Bushing.....	DC-B-7526-A.....	\$5 each
53-56 Brake & Clutch Pedal Bushing - F100 to F500.....	DC-7EQ-5344-A.....	\$3 each
48-56 Gas Pedal Pad With Pivot & Moulded Ball Mount.....	DC-TAAA-9735-A.....	\$17



Brakes

» Brake Lines & Cables



Brake Lines & Hoses

48-52 Brake Hose - Front - F1 Only.....	DC-8M-2079.....	\$19 each
53-56 Brake Hose - Front - Rubber.....	DC-TAAA-2078-A.....	\$19 each
48-60 Rear Brake Hose - Rubber.....	DC-8A-2078.....	\$19 each



Parking Brake Cable (Emergency Brake)

48-52 Parking Brake Cable - Front - Need 1 Per Truck.....	DC-2C-2853-A.....	\$60
53-56 Parking Brake Cable - Front - Need 1 Per Truck.....	DC-TAAA-2853-A.....	\$59
48-52 Parking Brake Cable - Rear - Need 2 Per Truck.....	DC-1C-2275-A.....	\$50
53-60 Parking Brake Cable - Rear - Need 1 Per Truck.....	DC-TAAA-2275-A.....	\$69
48-72 Parking Brake Lever to Brake Shoe Clip.....	DC-91A-2106.....	\$1 each
39-56 Parking Brake Hand Lever to Pawl Spring.....	DC-91A-2788.....	\$3 each
53-72 Parking Brake Cable Clip - Need 4 Per Truck.....	DC-8M-2814.....	\$2 each

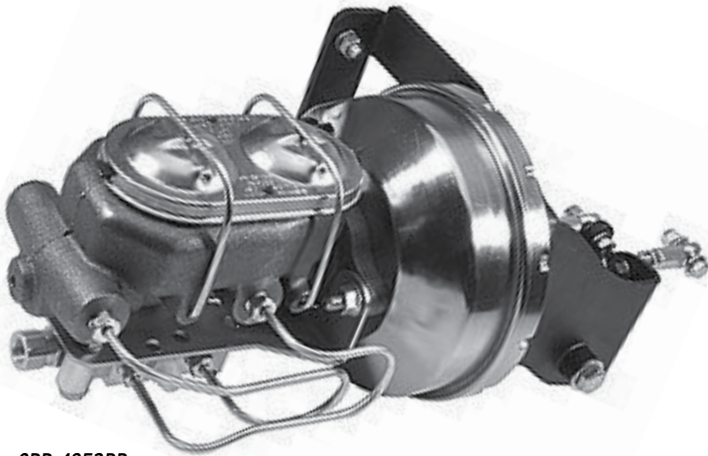

CPP-4852BB

48-52 Brake Master Cylinder & Booster Kit - Under Floor

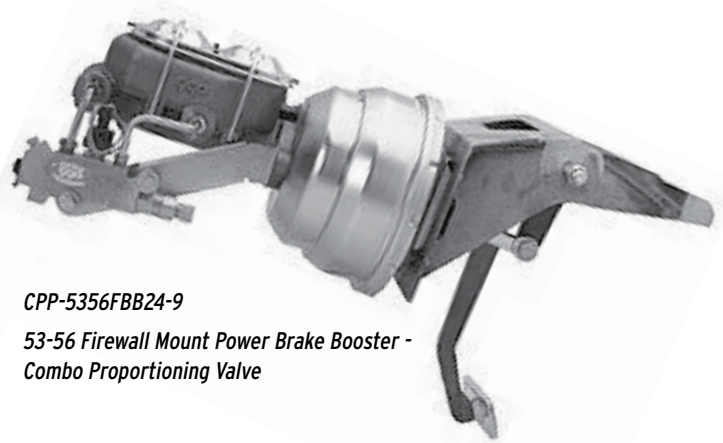

CPP-5356FBB24-9

53-56 Firewall Mount Power Brake Booster - Combo Proportioning Valve

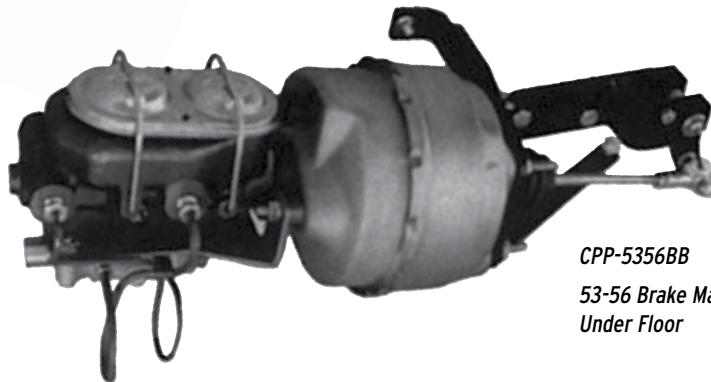

CPP-5356BB

53-56 Brake Master Cylinder & Booster Kit - Under Floor

DUAL MASTER CYLINDER

Power Booster & Master Cylinder Kits

All new components. 7" dual diaphragm brake booster - Drum/Drum, Disc/Disc or Disc/Drum Application master cylinder. Proper proportioning valve already installed (not used on drum/drum applications). All bracketry included to bolt in. Retains the stock brake pedal.

48-52 Brake Master Cylinder & Booster Kit - Under Floor CPP-4852BB..... \$389
 Above only works with auto transmissions - No clutch kit available.

53-56 Brake Master Cylinder & Booster Kit - Under Floor CPP-5356BB..... \$389

YES you can keep the clutch pedal if you are running a stick shift, but you need to add the clutch conversion kit:

Clutch Conversion Kit

53-56 Clutch Conversion Kit For Under Floor Brake Booster Kits CPP-5356CK1 \$69

Allows use of clutch pedal with CPP under floor brake boosters.

Dual Master Cylinder & Bracket (Manual)

53-56 Manual Dual Master Cylinder & Bracket Kit - Disc/Drum CPP-4756MMK-2..... \$249

53-56 Manual Dual Master Cylinder & Bracket Kit - Disc/Disc CPP-4756MMK-4..... \$249

Upgrade your 1953-56 Ford truck from a single to a Corvette-style dual reservoir master cylinder. Bracket and hardware included. Available for disc/drum and disc/disc applications.

Note: Manual transmission requires additional parts CPP-5356CK1 \$69

Allows use of clutch pedal with CPP under floor brake boosters.

Remote Reservoir Kit For CPP Dual Reservoir - Plastic CPP-RRCK \$129

Remote Reservoir Kit For CPP Dual Reservoir - Billet Aluminum CPP-BRCK \$279

- Mount the remote reservoir on the firewall (or anywhere you can) for easier access to fill your under floor master cylinder.

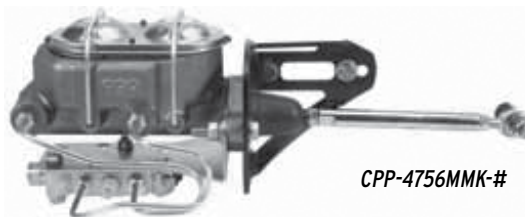

CPP Firewall Brake Booster Kits

Our firewall mount power brake booster kits are made to be compact and allow for clearance of any valve cover combination. Once installed the firewall, dash and steering column become triangulated making the entire assembly extremely rigid. Kit includes firewall mount bracket with pedal assembly, power brake booster, master cylinder, proportioning valve, and all mounting hardware. Bracket also available separately. Please specify drum/drum, disc/drum or disc/disc. Some modification to the dash may be necessary.

53-56 Firewall Mount Power Brake Booster - Drum/Drum Only CPP-5356FBB2-9..... \$389

53-56 Firewall Mount Power Brake Booster - Combo Proportioning Valve CPP-5356FBB24-9..... \$389

- This kits has a combination proportioning valve to run on disc/disc or disc/drum brake setups. You can take the proportioning valve off to run a drum/drum brake setup.

- This has a 9" booster.

FRONT DISC BRAKES



Complete Front Power Disc Brake Kits With Booster

Our complete disc brake kits not only upgrade your truck to power disc brakes, but they also allow you to keep either the stock 5 on 5-1/2" bolt pattern or change over to the popular 5 on 4-1/2" or 5 on 4-3/4" bolt patterns without having to use the stock hubs. This is our most popular upgrade for F-1's. Kits include rotors, loaded calipers, mounting brackets, bearings, seals, hoses, 8" power booster, master cylinder, proportioning valve and all necessary hardware. Specify disc/disc or disc/drum when ordering. Will not work with factory clutch pedal. (Automatic transmission only.)

48-52 - Complete Front Disc Brake Kit - F1 - 5 on 4-1/2" Wheel	CPP-4852CBK4.5	\$749
48-52 - Complete Front Disc Brake Kit - F1 - 5 on 4-3/4" Wheel.....	CPP-4852CBK4.75	\$749
48-52 - Complete Front Disc Brake Kit - F1 - 5 on 5-1/2" Wheel.....	CPP-4852CBK5.5	\$749
1953-56 - 5 on 4-1/2", Complete Front Disc Brake Kit	CPP-5356CBK4.5	\$749
1953-56 - 5 on 4-3/4", Complete Front Disc Brake Kit.....	CPP-5356CBK4.75	\$749
1953-56 - 5 on 5-1/2", Complete Front Disc Brake Kit	CPP-5356CBK5.5	\$749

Sub a firewall mount brake booster assembly for no additional charge



CPP Front Disk Brake Kits (No Booster/Mater Cylinder)

Change your front drum brakes to disc brakes with one of our bolt on disc brake wheel kits. Available in 5 on 4-1/2", 5 on 4-3/4" and 5 on 5-1/2" bolt patterns. Kits bolt directly to the 1/2 ton stock spindle and do not require the use of the stock hub. Rotors, calipers, mounting brackets, bearings, seals, hoses and all mounting hardware included.

48-56 Front Disc Brake Kit - 5 on 4-1/2" Wheel	CPP-4856WBK4.5	\$475
48-56 Front Disc Brake Kit - 5 on 4-3/4" Wheel.....	CPP-4856WBK4.75	\$475
48-56 Front Disc Brake Kit - 5 on 5-1/2" Wheel.....	CPP-4856WBK5.5	\$475

CPP Front Disk Brake Bracket Kits



Convert your straight axle truck to disc brakes with one of our bolt-on disc brake bracket kits. Our kits are designed to bolt on to our stock spindles using existing mountings holes. Blanchard ground to exact specs. Allows for perfect caliper fit. Kits are available to accept 5 on 4 1/2", 5 on 4 3/4" and 5 on 5 1/2" bolt pattern rotors. Calipers, pads, rotors, etc. can be purchased from your local auto supplier. A list of parts is included to complete the brake set-up.

48-56, Front Disc Brake Bracket Kit - 5 on 4-1/2" Wheel.....	CPP-4856DBK4.5	\$110
48-56, Front Disc Brake Bracket Kit - 5 on 4-3/4" Wheel	CPP-4856DBK4.75	\$110
48-56, Front Disc Brake Bracket Kit - 5 on 5-1/2" Wheel.....	CPP-4856DBK5.5	\$110
Braided Brake Hose For CPP Disc Brake Bracket Kits - Stainless Steel.....	CPP-BHK-S7-38	\$59

16" long - 7/16ths banjo with a 3/16ths female end.

Steering Box



48-60 Gasket - Steering Box Gasket Set.....	DC-7C-3581.....	\$12
48-60 Steering Shaft Felt Seal - Need 1 Per Truck.....	DC-21C-3738-A.....	\$3
48-52 Steering Sector Shaft Bushing.....	DC-78-3576-A.....	\$4
53-56 Steering Sector Shaft Bushing - Need 2 Per Truck.....	DC-81T-3576-A.....	\$6 each
42-79 Upper Steering Column Bearing.....	DC-C3DZ-3517-A.....	\$13
53-55 Steering Shaft & Worm Assembly.....	DAL-TAAA-3524-A.....	CALL
56 Steering Shaft & Worm Assembly.....	DAL-B6C-3524-A.....	CALL
48-52 Steering Box Rebuild Kit.....	CPP-4852SOK.....	\$310
53-55 Steering Box Rebuild Kit.....	CPP-5355SOK.....	\$310
56 Steering Box Rebuild Kit.....	CPP-56SOK.....	\$310

Tie Rod Ends & Tube



35-64 Tie Rod End With LH Threads.....	ROC-ES416L.....	\$15
35-64 Tie Rod End With RH Threads.....	ROC-ES416R.....	\$15
35-70 Tie Rod End Seal - Need 2 Per Truck.....	DC-8M-3332.....	\$2 each
32-52 Tie Rod Tube - With Clamps - F1, F2, F3.....	DC-21A-3282.....	\$129
53-60 Tie Rod Tube - F100 & F250.....	DC-TAAA-3281.....	\$80

Steering Stabilizer

53-64 Steering Stabilizer Kit - F100-F350.....	MOG-SSD99.....	CALL
--	----------------	------

Pitman Arm



48-52 Pitman Arm.....	DC-8C-3590.....	\$139
53-56 Pitman Arm - F100 & F250 Only.....	DC-TAAA-3590-A.....	CALL
48-56 Stud & Ball for Left Spindle - F100 & F250.....	DC-TAAA-3284.....	\$24

Drag Link



48-56 Drag Link - Complete With Internal Parts/Rubber Seals.....	DC-TAAA-3304-S.....	\$95
48-56 Drag Link End Repair Kit - Need 2 Kits Per Truck.....	DC-A8TZ-3A533-A.....	\$19 each
48-56 Rubber Cover For Drag Link End - Need 2 Per Truck.....	DC-7RC-3336.....	\$7 each

Steering Wheel

48-52 Steering Wheel - F1 to F6.....	DAL-8T-3600.....	\$249
53-55 Steering Wheel - Nice OE Reproduction.....	DAL-TAAA-3600.....	\$259
56-60 Steering Wheel - Nice OE Reproduction.....	DAL-B6C-3600.....	\$259
48-62 Steering Wheel Nut.....	PMC-2757.....	\$3
48-55 Gear Shift Knob - Ball Shape - Black.....	DC-7C-7213.....	\$7
56-60 Gear Shift Knob - Elongated Oval Shape - Black.....	DC-B6C-7213.....	\$8
53-60 Steering Column to Dash Bracket Anti-Squeak.....	DC-TAAA-3693.....	\$3

Power Steering

No More Ironman Turns!



Power Steering Kit

These kits consists of parts to convert your Ford pickup truck straight axle pickup to power steering. The kit comes with a NEW power steering box, mounting brackets, hoses, hardware and a pitman arm to fit your stock drag link. Also includes power steering hoses. These power steering kits are a great way to add power steering to a straight axle Ford pickup. Works with almost all power steering pumps. PS pump is not included. Power steering rubber hoses and several fittings to fit common pumps are included.

48-52 Power Steering Conversion Kit..... CPP-4852PSK-OC \$599

Will not work with 3 speed on the column shift linkage.

53-56 Power Steering Conversion Kit - For Stock Steering Column..... CPP5356PSK-OC..... \$649

Will not work with 3 speed on the column shift linkage. Includes 3/4 smooth (pinned) rag joint.

53-56 Power Steering Conversion Kit - With 1" DD to 30 Spline Rag Joint..... CPP5356PSK-AC \$680

Use this kit for aftermarket steering columns (Ididit/Flaming River. Includes a rag joint to match steer box to column).

Accessories

48-56 Steering Column Saver Kit - F100 CPP-F100CS \$17

Above is a flange bearing and collar to add lower support once you cut your OEM steering box off of the steering column.

Mini Rag Joint - 1" DD to 3/4 x 30 spline For 400 Series Box..... CPP-CP59084 \$79

Power Steering Pump Kits & Brackets

Small Block Ford Kit CPP-PSPK-SBF400..... \$344

Straight 6 Cylinder Kit (200/250 I6)..... CPP-PSPK-6F \$344

Y-Block Kit..... CPP-PSPK-YBLOCK# \$439

Kits Include pump & pulley, bracket & hoses.

Power Steering Bracket Kit- 200/250 I6 CPP-802410..... \$89

Power Steering Bracket Kit - Small Block Ford 289/302/351W..... CPP-802409..... \$89

Power Steering Bracket Kit- 292/312 Y-Block..... CPP-802411..... \$169

Heavy Duty Tie Rod & Tie Rod Ends

48-52 Heavy Duty Tie Rod & End Kit..... CPP-4852TRK..... \$115

53-64 Heavy Duty Tie Rod & End Kit - 2WD Only..... CPP-5364TRK..... \$115

Heavy duty tie rod kits consist of a larger diameter than stock tie rod and new style tie rod ends. This is a good upgrade to any truck, but especially if you upgrade to power steering. This kit fits just like the original tie rod and ends. It is a bolt in kit. No drilling or reaming required.





Stock Suspension Lowering

- 53-56 Rear End Conversion Kit For 3" Diameter Rear or 4"-5" Drop CPP-5356RCK\$109
- 48-56 Rear Shackle Kit - Lowers Rear 1.5 Inches CPP-4856SHK-RE\$109
Shackles come complete with urethane bushings and hardware. New pins not included.



Front Suspension - Original

- 48-56 Acorn Frame to Front Axle Bumper - F1/F100 DC-7RC-3020\$10 each
- 42-56 U-Bolt - Front leaf springs - Fits F1 and F100 DC-B3C-5455-A\$10 each
- 42-52 King Pin Bolt Kit - F1, F2, F3 DC-21A-3111\$79
- 53-56 King Pin Rebuild Kit - F100 and F250 - Does Both Front Wheels DC-B3C-3111-A\$73
- 48-52 Ford Truck F1-F2-F3 Front Leaf Spring - Shackle Bar - Outer DC-7RC-5469\$8
- 48-56 Front Shackle Bar - Inner - F100 & F250 DC-7RC-5468\$8 each
- 53-56 Front Shackle Bar - Outer - F100 & F250 DC-B5C-5469 CALL
- 53-56 Front Spring Hanger - Fits LH or RH LM-45-1391 Call
- 53-56 Rear Spring Hanger - Front Suspension - Fits LH or RH LM-45-1393 Call
- 48-52 Front Spring Shackle Rebuild Kit (Pins & Bushing Set) - F1, F2, F3 DC-7C-5300-S\$65
- 53-56 Front Spring Shackle Rebuild Kit (Pins & Bushing Set) DC-BAAA-5300-S\$65
- 48-52 Front Spring Shackle Pin - Front Upper - Need 2 Per Truck DC-7RC-5465\$19
- 42-56 Front Leaf Spring Shackle Pin - 42-47/53-56 use 6 Per Truck • 48-52 use 4 DC-21C-5465\$7 each
- 42-56 Front Leaf Spring Shackle Bushing - Need 4 Per Truck DC-21C-5348-A\$6 each
- 53-56 Front Suspension Frame Bracket Bushing - Need 2 Per Truck DC-21C-5344-A\$6 each
- 48-52 Shock - Front - F1, F2, F3 DC-A8C-18124-A\$55
- 53-55 Shock - Front or Rear - F100 - Monro-Matic Plus MON-32207\$32 each
- 56 Shock - Front - F100 DC-B6C-18124\$49 each



Front Leaf Springs

- 48-52 Front Leaf Springs - Pair CPP-4852FLS-S CALL
- 53-56 Front Leaf Springs - Stock Height - Pair CPP-5356FLS-S CALL
- 53-56 Front Leaf Springst - 2" Lower - Pair CPP-5356FL-DF CALL



Now available are new stock height and drop leaf springs for your car or truck. These are not reconditioned originals, but new leaf springs made to the original factory specs. Sold in pairs. Does not include bushings or U-bolts. Note: Will not work with vehicles that were equipped with monos.

Suspension

» Rear & 4 Link Upgrade



Rear Suspension - Original

48-56 Bumper For Rear Axle to Frame	DC-11A-3020-A.....	\$8 each
42-56 U-Bolt - Rear Leaf Springs - 4 Per Truck.....	DC-21C-5701-C.....	\$10 each
42-52 Rear Swing Hanger - F1 Only	DC-21C-5776.....	\$40
53-56 Rear Swing Hanger - Fits: F100.....	DC-TAAA-5776-A.....	\$42
53-56 Rear Swing Hanger - F250	DC-TBAA-5776-A.....	CALL
32-56 Shackle Lock Pin & Nut.....	DC-82Y-5782.....	\$3
48-56 Rear Spring Shackle Rebuild Kit (Pins & Bushing Set).....	DC-7C-5630.....	\$65
42-56 Rear Leaf Spring Shackle Pin (Need 6 per truck).....	DC-21C-5780.....	\$7 each
42-57 Ford Truck Rear Swing Hanger Bushing - Need 2 per truck.....	DC-21C-5791-A.....	\$6 each
42-56 Rear Leaf Spring Bushing - Need 4 Per Truck.....	DC-21C-5781-A.....	\$7 each

Rear Leaf Springs

53-54 Stock Rear Leaf Springs - F100 - Pair	5354RLSS	CALL
55-56 Stock Rear Leaf Springs - F100 - Pair	5556RLSS	CALL

Now available are new stock height and drop leaf springs for your car or truck. These are not reconditioned originals, but new leaf springs made to the original factory specs. Sold in pairs. Does not include bushings or U-bolts. Note: Will not work with vehicles that were equipped with monos.



Rear 4 Bar Suspension

48-72 Fatbar 4 Link Rear Suspension Kit	NOL-FTBR-1	\$2,195
---	------------------	---------

The No-Limit Fatbar 4-link suspension is designed for 1948-1972 Ford F1 and F100 pickups! It is a complete 4 - Link kit. Fatbar 4-Links use a 220lb spring and a 5" single adjustable shock for a smooth ride. No Limit designed the Fatbar with longer bars to allow a smoother weight transfer.

IFS

Ford Truck Mustang II IFS System By CPP

48-52 Complete Mustang II IFS System.....	CPP-E4852M2IFS-K.....	\$2,100
53-56 Complete Mustang II IFS System.....	CPP-E5356M2IFS-K.....	\$2,100

- Choose 5 x 4.5", 5 x 4.75", 5 x 5" or 5 x 5.5" Lug Pattern No Additional Cost
- Choose Manual or Power Rack..... No Additional Cost
- Choose Stock or 2" Dropped Spindles No Additional Cost

Enjoy the comfort and benefits of having an independent suspension system in your early truck without paying the big prices of other kits. These kits come with crossmember, frame boxing plates, coil springs, spindles, brakes, shocks, upper and lower control arms, rack & pinion, plus mounting hardware. Specify manual or power steering and stock or 2" dropped spindles. Rotor bolt lug options are: 5 x 4.5, 5 x 4.75, 5 x 5.5, 5 x 5.

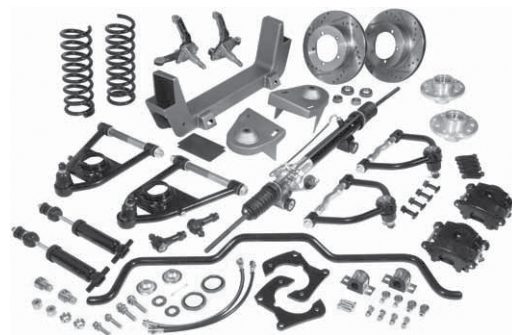

A Great Deal!



Sway Bar Kits For Stock Suspension

48-56 Rear 1" Sway Bar Kit	CPP-CPP169.....	\$189
53-56 Front Sway Bar - 1 Inch.....	CPP-CPP12030.....	\$189

Sway bars are the key to having a great handling vehicle. They reduce body roll and help control over steer and under steer in corners. Kits come complete with sway bar, poly bushings, mounting brackets and all necessary hardware. Black powder coated finish.



Ford 3 Inch Rear End Conversion Kit

53-56 Rear End Conversion Kit For 3" Diameter Rear	CPP-5356RCK	\$109
--	-------------------	-------

Our kit allows you to update your existing axle to any 3" diameter rear, including GM 10- and 12-bolt, F-Body 7.5", Ford 9", or any other axle with 3" diameter axle tubes. Can also be used as a flip kit for 4" to 5" drop. Welding is required. This kit also contains provisions for modern shock absorber mounting.

Front Hub Parts

48-56 Front Wheel Bearing Race - Outer	DC-8A-1217	\$8 each
Fits: 48-52 F1, F2 and F3 as well as 53-56 F100 and F250		
48-56 Front Wheel Bearing Race - Inner	DC-01Y-1202	\$8 each
Fits: 48-52 F1, F2 and F3 as well as 53-56 F100 and F250		
48 - 56 Wheel Bearing - Outer	DC-8A-1216	\$17 each
Fits 48-52 F1, F2 and F3 as well as 53-56 F100 and F250		
48-56 Wheel Bearing - Inner	DC-01Y-1201	\$18 each
Fits 48-52 F1, F2 and F3 as well as 53-56 F100 and F250		
48-56 Front Hub Grease Cap - Push In Type - 1-15/16" Inch Diameter	DC-51A-1139	\$7 each
48-56 Front Hub Grease Seal - 2-3/4 Inch OD	DC-01Y-1190-A	\$5 each



Wheels

48-60 Hub Cap - "FORD" - Stainless Steel	DC-6A-1130-A	\$40 each
32-79 Lug Nut - 1/2"	DC-B-1012	\$1 each
48-79 Wheel Trim Ring - 15" - Polished Stainless Steel - Smooth Convex Shape	OVL-15-18303-C	\$25 each
48-79 Wheel Trim Ring - 15" - Polished Stainless Steel - Smooth Shape	OVL-15-18303-S	\$29 each
48-79 Wheel Trim Ring - 15" - Polished Stainless Steel - Ribbed	OVL-15-18303-R	\$25 each
Wheel Trim Ring - 16" - Stainless Steel	DC-6A-18303-16	\$35 each
Wheel Trim Ring - 15" - Universal - Polish Stainless Steel - Ribbed	UAP-A6224-5	\$23 each

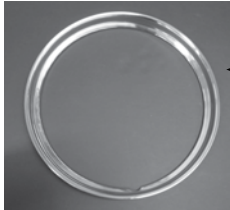

Buy Online @
www.CMWTrucks.com



Scan The QR Code With Your Mobile
 Phone's Camera to go to our website



***Our Website Can Be Very
 Helpful In Building Your Truck***

WIRING HARNESSES



Dash Wiring Harnesses

48-50 Dash Wiring Harness - 6 cyl.....	DC-8HC-14401-C	\$499
Ignition Switch on Right Side of light switch		
49-50 Dash Wiring Harness - 6 Cyl.....	DC-8HC-14401	\$525
Ignition Switch on Left Side of light switch		
48-50 Dash Wiring Harness - V8	DC-8RC-14401	\$575
51 Dash Wiring Harness - V8	DC-1RC-14401	\$549
52 Dash Wiring Harness - V8	DC-2RC-14401	\$550
53 Dash Wiring Harness - 6 cyl.....	DC-FAL-14401-A	\$499
53 Dash Wiring Harness - V8	DC-FAK-14401-A	\$549
54 Dash Wiring Harness - V8	DC-FDE-14401-AB	\$525
55 Dash Wiring Harness - PVC - V8	DC-B5C-14401-F	\$649
56 Dash Wiring Harness - PVC - 6cyl	DC-B6C-14401-G	\$749
56 Dash Wiring Harness - PVC - V8	DC-B6C-14401	\$749

Modern Style Wiring Harnesses

EZ Wiring - Universal Wire Harness Kit - 18 Fuse, 21 Circuit..... EZW-EZ-21..... \$219
 This 18 fuse, 21 circuit wiring harness kit uses GXL 125 high temp cross linked polyethylene jacketed wire that is grease, oil, gas, and acid resistant. Each wire is labeled every 5 inches to make installation easier. **MADE IN USA.**

Radio, Coil, Dome Light, Backup/Cruise, Horn, Cigarette Lighter, Fuel Pump, AC/Heat, Radio, Turn Signal, Horn, ACC, Wiper, Gauges, Hazard, Fan, Power Window, Power Door Locks, Brake, Headlights circuits.

Wiring Accessories



Voltage Reducer - Reduces 12 volt to 6 volt	DC-U-10800	\$25
Dash Gauge Voltage Reducer - Reduces 12 volt to 6 volt	DC-D-10800.....	\$40
Does Fuel, Temp & Oil Gauges		
48-56 Grommet - Main Wiring Loom	DC-1A-14603-B.....	\$4
48-66 Main Wiring Loom Retainer	DC-8A-14608.....	\$11
39-66 Female Pigtail for Master Cylinder Brake Switch - Pair.....	DC-B6A-13644-R.....	\$5 pair
48-50 & 53-56 Grommet - Choke & Throttle Cable Grommet	DC-B-14605.....	\$2 each
53-56 Grommet - Vacuum Wiper Hose Grommet.....	DC-BAAA-17545	\$3 each
56 Grommet - Electric Wiper Motor Cable Grommet.....	DC-8A-14605-A.....	\$2 each
56 Water Temperature Sending Unit - 12 volt	DC-B6C-10884.....	\$49

» Headlights



Headlights

48-55 Headlight Bucket - LH or RH.....	DC-1C-13008-A.....	\$75
56 Headlight Bucket - LH or RH.....	DC-B6C-13008-A.....	\$85
42-56 Gasket - Headlight Bucket to Grille - Need 2 Per Truck.....	DC-11A-13044.....	\$4 each
48-56 Headlight Bucket Spring - Need 2 Per Headlight.....	DC-11A-13031.....	\$2.25 each
40-66 Round Headlight Headlamp Retainer Ring - Stainless Steel - Like OEM.....	DAL-01A-13018-SS.....	\$12
42-57 Headlight Adjusting Ring.....	DC-8A-13041.....	\$30
48-56 Headlight Adjusting Screws - Pair.....	DC-8A-13032.....	\$6
53-55 Headlight Knob - With Shaft.....	DC-BAAA-11661.....	\$9
56 Headlight Knob - With Shaft.....	DC-B6C-11661.....	\$9
41-50 Switch - Headlight Switch - 6 volt - No Shaft or Knob.....	DC-11A-11652.....	\$45
48-54 Switch - Headlight Switch - 6 or 12 volt - No Knob.....	DC-FAA-11654-A.....	\$49
55 Switch - Headlight Switch - 6 or 12 volt - No Knob.....	DC-B5T-11654-A.....	\$55
56-57 Switch - Headlight Switch - 12 volt - No Knob.....	DC-B6T-11654-A.....	\$49
53-54 Nut - Headlight Switch to Instrument Panel.....	DC-FAB-11662-A.....	\$7
55-64 Nut - Headlight Switch to Instrument Panel.....	DC-C2TZ-11650-A.....	\$9
48-56 Headlight Dimmer Switch - Floor Mount.....	DC-8A-13532.....	\$20
48-55 Headlight Bezel - Polished Stainless Steel.....	DC-FAD-13045.....	\$25
56 Headlight Bezel - Reproduction.....	OVL-B6C-13064-A.....	CALL
51-56 Headlight Bezel Screws - A pair does one truck.....	DC-52388-SSHL.....	\$1 pair
48-50 Headlight Crossover Wire.....	DC-7HC-11653.....	\$48
51-52 Headlight Crossover Wire.....	DC-1C-11653-A.....	\$49
53-55 Headlight Crossover Wire.....	DC-B4TZ-13A006-A.....	\$65
56 Headlight Crossover Wire.....	DC-B6C-11653-A.....	\$64
48-55 Headlight Bucket Wiring - Like OEM With Rubber Cover.....	DC-0A-13076.....	\$44
46-56 Grommet - Wiring Headlight.....	DC-51A-13077.....	\$2.50 each
Ford OE Male Wire Bullet Ends - 14 to 16 Gauge Wire.....	DAL-B-14486-S.....	\$4 For 10
Ford OE Wiring Connectors - 2 Wire - OE Bullet Ends Fit These.....	DAL-B-14487-K.....	\$6 For 10
Ford OE Female Wiring Connector - 4 Wire - OE Bullet Ends Fit These.....	DC-59A-14487.....	\$4 each
51-52 Headlight Support - LH.....	AMD-151-4551-L.....	\$40
51-52 Headlight Support - RH.....	AMD-151-4551-R.....	\$40



Dome Lights



51-52 Dome Light Assembly	DC-1C-13783	\$45
51-52 Gasket - Dome Light Lens Gasket	DC-1C-13876	\$3
53-56 Dome Light Assembly - Housing & Lens - With Switch Hole	OVL-53F-13771-CWS	\$49
53-56 Dome Light Assembly - Housing & Lens - No Switch Hole	OVL-53F-13771-CNS	\$49
53-56 Dome Light/Lamp Socket & Wire	DC-BA-13560	\$10
48-52 Dome Light Lens - Plastic	DC-8T-13783	\$10
53-56 Lens - Dome Light/Lamp	DC-8M-13783	\$7
51-56 Switch - Dome Light/Lamp Switch - Door Jamb	DC-8M-13713	\$7.50
53-56 Switch - Dome Light/Lamp - Use On Dome Light Body	DC-BAAA-13752	\$15



Antenna

48-52 Antenna - OE kit	DC-6A-18813	CALL
53-55 Antenna - OE - kit	DC-BAAA-18813-A	\$99
56 Antenna - OE - kit	DC-B6C-18813-B	\$99

Battery

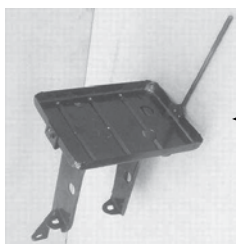

48-51 Battery to Motor Block Ground Cable	DC-78-14301	\$30
33-52 Battery Hold Down Top Frame	DC-51A-5165-A	\$20
48-52 Battery Hold Down J Bolt	DC-11A-5175-E	\$3.50 each
48-52 Battery Hold Down Top Frame Nut & Washer Kit For J Bolt	DC-11A-5179-S	\$5 pair
48-52 Battery Tray - V8 Only	MEF-7RC-10732-C	\$100
54-55 Battery Box Assembly	AMD-X340-4554	\$55
56-60 Battery Box Assembly	AMD-X340-4556	\$55
54-55 Battery Hold Down J Bolt	PMC-0124-568	\$4
54-55 Battery Hold Down Top Frame	DC-B5A-10718-A	\$16
53-55 Battery Hole Cover (Locking)	AMD-341-4553-2	\$49
53-55 Battery Hole Cover Seal	DC-BAAA-8101645-B	\$12
56 Battery Hole Cover (Locking)	AMD-341-4556-2	\$60
56 Seal For Battery Hole Cover	DC-B6C-8101645-B	\$12



**Scan The QR Code
With Your Mobile Phone's Camera
to go to our website**



» Horn & Parking Lights

Horn Switch, Contact & Wiring

48-55 Horn Relay - 6 volt	DC-7RA-13853	\$33
56 Horn Relay - 12 volt	DC-B6A-13853	\$18
48-60 Horn Button Spring	DAL-A7TZ-13A807-A	\$5
48-60 Horn Button Index Spring	DC-7RC-14479	\$3
48-52 Horn Index Plate	DAL-A7TZ-13A809-A	\$10
48-60 Horn Contact Button or Plate	DC-7RC-3631	\$5
48-55 Horn Contact Wire	DC-FAB-14308-A	\$20
53-60 Horn Button Cup or Support	DAL-B3TZ-13A809-A	\$9
48-52 Horn Button & Wire Kit	DAL-7C-13809-KIT	\$35
53-60 Horn Button Wire & Contact Kit	DAL-BAAA-13809-KIT	\$35



Horn Buttons

48-52 Horn Button - Black Plastic	DC-7HC-3627-C	\$20
53 Horn Button - 50th Anniversary - Complete Assembly	DC-BAAA-3627-A	CALL
53 Horn Button - 50th Anniversary - Insert Only	DC-BAAA-3627-ANV	\$52
53-60 Horn Button - White Center - Gear & Thunderbolt	DC-BAAA-3627	\$57
53-60 Horn Button - Polish SS Center - Gear & Thunderbolt	DC-BAAA-3627-SS	\$57
54-56 Horn Button - 5 Star Cab - Stainless Steel With Black Center	DC-B4C-3627-A	\$57
54-56 Horn Button - 5 Star Cab - Stainless Steel	DC-B4C-3627-SS	\$62
56 Horn Button - Red Center - Gear & Thunderbolt	DC-B6C-3627-A	\$57



Parking Light Assemblies

	48-50 Parking Light Assembly - Stainless Steel Bezel - Clear Lens.....	DAL-7RC-13200	\$36
	51-52 Parking Light Assembly- Clear Lens - Plain Steel Bezel	DAL-1C-13200-A.....	\$34
	51-52 Parking Light Assembly - Clear Lens - Stainless Steel Bezel.....	DAL-1C-13200-SS	\$39
	53-54 Parking Light Assembly - 12 volt - Clear Lens - Painted Bezel.....	DAL-FAD-13200-A	\$45
	53-54 Parking Light Assembly - 12 volt - Clear Lens - Stainless Steel Bezel	DAL-FAD-13200-SS	\$49
	55 Parking Light Assembly - 12 volt - Clear Lens - Painted Bezel.....	DAL-B5C-13200-A	\$45
	55 Parking Light Assembly - 12 volt - Clear Lens - Stainless Steel Bezel	DAL-B5C-13200-SS	\$49
	56 Parking Light Assembly - 12 volt - Clear Lens - Painted Bezel.....	DAL-B6C-13200-A	\$49
	56 Parking Light Assembly - 12 volt - Clear Lens - Stainless Steel Bezel	DAL-B6C-13200-SS	\$49

Parking Light Parts

	48-50 Parking Light Wire & Socket Set - 1 Contact.....	DC-7RC-13234.....	\$22
	48-55 Parking Light Wiring Repair Kit - 1 Wire, 2 Retainers, Spring.....	DC-7C-13410-A.....	\$5 each
	Taillight or Parking Light Wiring Socket - 2 Wire - Metal Replacement.....	DC-BAAA-13410	\$8 each
	51-52 Bezel - Parking Light - Steel.....	DAL-1C-13210-A.....	\$12 each
	51-52 Bezel - Parking Light - Stainless Steel.....	DAL-1C-13210-SS	\$15 each
	53-54 Bezel - Parking Light - Painted.....	DAL-FAC-13210-A.....	\$11 each
	53-54 Bezel - Parking Light - Stainless Steel	DAL-FAC-13210-SS.....	\$16 each
	55 Bezel - Parking Light - Painted.....	DAL-B5C-13210-A	\$12 each
	55 Bezel - Parking Light - Stainless Steel	DAL-B5C-13210-SS	\$15 each
	56 Bezel - Parking Light - Painted.....	DAL-B6C-13210-A.....	\$12 each
	56 Bezel - Parking Light - Stainless Steel	DAL-B6C-13210-SS	\$15 each
	48-50 Gasket - Parking Light Lens Gasket - Pair	DC-7RC-13211	\$4 pair
	51-52 Gasket - Parking Light Lens Gasket - Pair	DC-1C-13211	\$6 pair
	53-54 Gasket - Parking Light Lens Gasket - Pair	DC-FAE-13211-A.....	\$6 pair
	55-56 Gasket - Parking Light Lens Gasket - Pair	DC-B5C-13211.....	\$6 pair
	48-50 Lens - Parking Light - Amber.....	DAL-7RC-13208-AMB	\$10 each
	48-50 Lens - Parking Light - Clear	DAL-7RC-13208.....	\$9 each
	51-52 Lens - Parking Light - Amber.....	DAL-1C-13208-AMB	\$12 each
	51-52 Lens - Parking Light - Clear	DAL-1C-13208-A.....	\$9 each
	53-54 Lens - Parking Light - Amber.....	DAL-FAE-13208-AMB.....	\$11 each
	53-54 Lens - Parking Light - Clear	DAL-FAE-13208-A.....	\$9 each
	55-56 Lens - Parking Light - Amber.....	DAL-B5C-13208-AMB.....	\$11 each
	55-56 Lens - Parking Light - Clear	DC-B5C-13208-B	\$10 each

» Taillight Assemblies

Shield Style Taillight

Options Are:

Driver (LH) or Pass. (RH)

Body: Black or Polished SS

Lens: Plain or with Blue Dot Installed

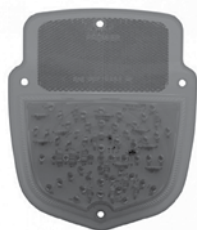

Taillight Assemblies - Round

48-54 Taillight Assembly - LH - Black Body - Stainless Steel Rim.....	DAL-48-13403	\$49
48-54 Taillight Assembly - RH - Black Body - Stainless Steel Rim	DAL-48-13402	\$30
33-52 Taillight Assembly - LH - Stainless Steel Body - Glass Lens.....	DC-01C-13403	\$40
33-52 Taillight Assembly - RH - Stainless Steel Body - Glass Lens	DC-01C-13402.....	\$40
40-52 Taillight Assembly - LH - Black Body - Glass Lens.....	DC-40-13403.....	\$40
40-52 Taillight Assembly - RH - Black Body - Glass Lens	DC-40-13402.....	\$40
48-54 Taillight Assembly - LH - Black Body With Stainless Steel Rim	DAL-48-13403	\$49
48-54 Taillight Assembly - RH - Black Body With Stainless Steel Rim.....	DAL-48-13402	\$30
48-54 Taillight Assembly - LH - Stainless Steel Body.....	DAL-40-13403-SS	\$35
48-54 Taillight Assembly - RH - Stainless Steel Body.....	DAL-40-13402-SS	\$35

Taillight Assemblies - Shield

53-56 Taillight Assembly - LH - Black Body - Plain Lens	UAP-A5011L	\$32
53-56 Taillight Assembly - RH - Black Body - Plain Lens.....	UAP-A5011R.....	\$30
53-56 Taillight Assembly - LH - Black Body - With Blue Dot	UAP-A5011LBD	\$39
53-56 Taillight Assembly - RH - Black Body - With Blue Dot.....	UAP-A5011RBD.....	\$37
53-56 Taillight Assembly - LH - Chrome Body - With Blue Dot.....	UAP-A5012LBD	\$32
53-56 Taillight Assembly - RH - Chrome Body - With Blue Dots.....	UAP-A5012RBD	\$29
53-56 Taillight Assembly - LH - Stainless steel - Plain Lens.....	UAP-A5018SSL.....	\$41
53-56 Taillight Assembly - RH - Stainless steel - Plain Lens	UAP-A5018SSR	\$39
53-56 Taillight Assembly - LH - Stainless Steel - With Blue Dot	UAP-A5018SSLBD	\$38
53-56 Taillight Assembly - RH - Stainless Steel - With Blue Dot.....	UAP-A5018SSRBD	\$31

LED Taillights (Use your existing shield style bodies)

53-56 LED Taillight Lens - LH - Shield Style.....	UAP-110142.....	\$57
53-56 LED Taillight Lens - RH - Shield Style.....	UAP-110143.....	\$49

Upgrade to LED tail lights! Installation is easy. Simply insert the LED wiring plug into your stock #1157 socket. Install the screws in the LED lens. LH has the license plate light built in.

Panel Truck Taillights

48-56 Taillight Assembly - Panel Truck - LH.....	DC-11A-13405	\$80
48-56 Taillight Assembly - Panel Truck - RH.....	DC-11A-13404	\$80

License Plate Light is on the LH Side of Truck.

Buy 2 RH side lights if you are moving your license plate away from the taillight.

» Taillight Accessories

Round Taillight Parts

33-52 Bezel - Taillight Lens Bezel - Chrome	DC-40-13448	\$8
35-52 Gasket - Taillight Lens Gasket - Pair	DC-40-13460-PR	\$6
35-52 Lens - Taillight - Glass	DC-40-13450	\$7
35-52 Lens - Taillight - Glass With Blue Dot	DC-40-13450-BD	\$18
53-54 Lens - Taillight - Round Style	DC-B3C-13450-P	\$6 each

Shield Taillight Parts (Stepside)

53-66 Lens - Taillight - Plain	UAP-A5015	\$7
53-66 Lens - Taillight - Plain - With Blue Dot	UAP-A5016	\$12
53-56 Lens - Taillight - Ford Block Letters	UAP-F535601	\$7
53-56 Lens - Taillight - Ford Block Letters - With Blue Dot	UAP-F535601BD	\$12
53-56 Lens - Taillight - Chrome Script	OVL-53F-13450-SCPT	\$16
53-56 Lens - Taillight - Chrome Script - With Blue Dot	DC-B5C-13450-SBD	\$30



Chrome Script Ford Logo - Adhesive Backed to Fit Shield Taillight Lenses	UAP-S1018	\$7 each
53-56 Gasket - Taillight Lens Gasket - Fits Shield Style	UAP-A5017	\$2 each
55-66 Gasket - Taillight Lens Gaskets - Pair - Shield Style	DC-B5C-13461	\$6 pair

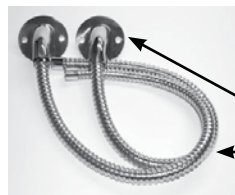

Taillight Wire Conduit

48-66 Tail Light Wire Shield - Stainless Steel - Need 2 Per Truck	UAP-A8050	\$7 each
19" Taillight Wire Conduit - Stainless Steel - Need 2 Per Truck	UAP-C5026	\$6 each

Taillight Brackets (Offset - Don't use with shield style lights)

38-56 Bracket - Taillight - LH - Stainless Steel	DAL-81Y-13471-SS	\$20
38-56 Bracket - Taillight - RH - Stainless Steel	DAL-81Y-13470-SS	\$20

Above brackets have offset bend - Can be used on 48 - 66 Ford Trucks - Taillight brackets sold each.



48-52 Bracket - Taillight - LH - Chrome	DC-7C-13471-CH	\$15
48-52 Bracket - Taillight - RH - Chrome	DC-7C-13470-CH	\$15

Can be used on 53 and up F100's.

Taillight Brackets (Flat - Use with Shield Style Lights)

53-56 Bracket - Taillight - Black	UAP-A5013	\$6
53-56 Bracket - Taillight - Polished Stainless Steel	UAP-A6217	\$13

Above brackets are flat and fit either side - Taillight brackets sold each.



Rear License Plate Brackets

48-72 Bracket - License Plate - Stepside - Black Steel	UAP-A1012	\$6
48-72 Bracket - License Plate - Stepside - Chrome	UAP-A1011	\$9
48-72 Bracket - License Plate - Stainless Steel	UAP-A1013	\$12





Turn Signals

53-56 Turn Signal Switch - Knob Only - Round.....	DC-1A-13305.....	\$6
56-57 Turn Signal Switch - Knob Only - Barrell Shape	DC-B4A-13305.....	\$6
53-56 Turn Signal Switch - No Lever or Knob.....	DC-B6C-13341-A.....	\$76
48-52 Jewel Turn Signal Indicator Light - Dash.....	DC-01C-13583.....	\$12
48-55 Turn Signal Flasher - 6 volt.....	DC-A9AZ-13350.....	\$10
LED Flasher - 2 Terminal - 12 volt With Polarity Reverser.....	UAP-90652.....	\$13
53-60 Truck Turn Signal Cancelling Cam.....	DC-FAA-13318-A.....	\$10

Switches

40-51 Starter Button - Chrome.....	DC-6A-11500.....	\$8.75
48-59 Starter Button - Black.....	DC-2C-11500.....	\$22
48-52 Ignition Cylinder With 1 Key - No Switch Housing.....	DC-8A-11582-A.....	\$25
52-60 Ignition Cylinder With 1 Key - No Switch Housing.....	DC-BA-11582-A.....	\$12
48-50 Ignition Switch Housing - No Cylinder/Keys	DC-6A-11572-B.....	\$65
51-52 Ignition Switch Housing - No Cylinder/Keys.....	DC-0L-11572-A.....	\$65
53-55 Ignition Switch Housing - No Cylinder/Keys.....	DC-FAA-11572-A.....	\$39
56-60 Ignition Switch Housing - No Cylinder/Keys	DC-B5A-11572-A.....	\$25
56-60 Ignition Switch to Dash Spacer (Mount Plate).....	DC-B7C-11597-A.....	\$11
53-60 Lock Set - 2 Door Lock Cylinder's - 1 Ignition & 1 Key.....	DC-BAAA-7022050-S.....	\$55
48-50 Bezel - Ignition Switch Dash Bezel.....	DC-0A-11580.....	\$15
51-52 Bezel - Ignition Switch Dash Bezel.....	DC-0L-11580.....	\$16
40-51 Switch - Starter Solenoid Switch - 6 volt - Metal Case - Has Push Button.....	DC-01A-11450.....	\$30
40-51 Switch - Starter Solenoid Switch - 6 volt - Metal Case - No Push Button.....	DC-21A-11450-M.....	\$30
52-55 Starter Solenoid - 6 volt.....	DC-FAB-11450-B.....	\$25
56-78 Starter Solenoid.....	DC-B6A-11450-A.....	\$24
48-52 Key Blank - Ignition or Door.....	DC-1A-3685-A.....	\$7
32-52 Key Blank - Ignition or Door - Anniversary.....	DC-APA-18316.....	\$12
53-66 Key Blank - Ignition or Door - F100 & F250.....	DC-BA-3685-A.....	\$6
39-66 Switch - Brake Light Switch.....	DC-01A-13480.....	\$8
51-56 Switch - Dome Light/Lamp Switch - Door Jamb.....	DC-8M-13713.....	\$7
48-54 Switch - Headlight Switch - 6 or 12 volt - No Knob/Dash Nut.....	DC-FAA-11654-A.....	\$49
56-57 Switch - Headlight - 12 volt - No Knob/Shaft.....	DC-B6T-11654-A.....	\$49
56-60 Switch - Turn signal Switch - 12 volt.....	DC-B6C-13341-A.....	\$76

You can also use it on 53, 54 and 55 Ford F100's if you've converted to 12 volt and are using the stock steering column.



Heater

53-56 Side Cowl Vent Block Off Plate.....	PMC-1938.....	\$36
53-56 Seal - Side Cowl Vent Seal.....	PMC-1937.....	\$8
48-56 Seal - Heater Tube Firewall - Need 2 Per Truck.....	DC-8C-18595.....	\$2 each
53-56 Seal - Recirculating Heater Seal Kit.....	DC-BAAA-18565-S.....	\$15
48-50 Heater Control Knob.....	DC-7C-9700.....	\$8
51-52 Heater Control Knob.....	DC-1C-9700.....	\$8
53-56 Knob Fits Heater, Defrost, Choke, Temp, or Throttle.....	DC-BAAA-9700.....	\$6 each
48-56 Heater, Choke or Throttle Cable Replacement - Cut to Fit.....	DC-7C-9700-U.....	\$17 each
48-55 Heater Blower Motor - 6 volt.....	DC-21A-18527.....	\$97
56 Heater Blower Motor - 12 volt.....	DC-B6C-18527.....	\$59
Defroster Hose 1-3/4" Inside Diameter - Sold By the Foot.....	DC-8H-18556-B.....	\$6.25/ft
Defroster Hose 2" Inside Diameter - Sold By the Foot.....	DC-FAB-18556-D.....	\$9/ft
Defroster Hose 2-1/2" Inside Diameter - Sold By the Foot.....	DC-B5A-18556-C.....	\$10/ft
39-64 Hot Water Heater - On/Off Valve.....	DC-91A-15142.....	\$15



www.CMWTrucks.com/Blog



LOGIN CART / \$0.00

[SHOP](#) [CONTACT](#) [BLOG](#) [ABOUT US](#) [CLASSIC TRUCK INFO](#) [SHIP, PRIV. & TERMS & COND.](#)

CALL 1-800-621-5030 : M-F 8AM - 5PM EST

53 - 56 FORD TRUCKS
Flawless 53 Ford

POSTED ON JANUARY 17, 2018 BY CMWTRUCKS



We first saw this 53 at the F100 SuperNationals in 2008. Fast forward to the Summer of 2017 and it's just as flawless as it was back then. While not everyone loves orange, this truck is awesome and begging to be looked at. Every inch of the body has been massaged and smoothed to perfection. [...]

Visit our blog to see classic truck features from all over the USA!

Scan The QR Code With Your Mobile Phone's Camera to go to the blog on our website



Engine & Transmission

» Mounts & Parts

Engine & Transmission Mounts



48-64 Engine Crossmember - 429C, 460.....	CPP-CP42960	\$110
Engine Mount Pad - 429, 460 - LH	CPP-2367L.....	\$35
Engine Mount Pad - 429, 460 - RH.....	CPP-2368R.....	\$35
48-64 Engine Crossmember - 260, 289, 302, 351W.....	CPP-CP4819	\$69
Engine Mount Pads - 260, 289, 302, 351W - Need 2 Per Truck.....	CPP-2310	\$20
48-64 Engine Crossmember - 351C, 400.....	CPP-CP4977	\$75
Engine Mount Pads - Late 351C, 400M - LT.....	CPP-2341L.....	\$25
Engine Mount Pads - Late 351C, 400M - RT	CPP-2341R.....	\$25
Engine Crossmember - 332, 352, 390, 406, 427, 428 Ford FE Blocks.....	CPP-CP35228.....	\$110
Engine Mount Pad - 332, 352, 390, 406, 427, 428, FE Block - Need 2 Per Truck.....	CPP-2141.....	\$29 each
48-64 Engine Crossmember - Chevy - SBC & BBC.....	CPP-CP4810	\$69
Small Block Chevy - Motor Mount Pads - Pair.....	CPP-2142-PR.....	\$32 pair
Small Block Chevy - Motor Mount Pads - Need 2 Per Truck.....	CPP-2142	\$16 each
Small Block Ford Engine Mounts - Weld In For IFS - NO Pads.....	CPP-CP4819-S.....	\$95
Small Block Chevy Engine Mounts - Fits BBC - Weld In For IFS.....	CPP-CP4810-S.....	\$79
LS V8 Engine Mounts - Weld In For IFS With Pads	CPP-4810-SLS.....	\$148
48-64 Transmission Crossmember.....	CPP-CP4136.....	\$69
Transmission Mount Pad - Ford C4, C6 & AOD.....	CPP-2333.....	\$18
Transmission Mount Pad - GM Automatic Transmissions	CPP-9425.....	\$14
Transmission Mount Pad - Polyurethane - GM Automatic Transmissions.....	CPP-CP-1108G.....	\$30

Transmission

48-56 Shift Linkage Repair Kit - Column Shift.....	DAL-01A-7354-RK	\$19
32-52 Gear sShift Boot - Floor Shifter.....	DC-99A-7242-B.....	\$16
53-60 Speedometer Cable - 3 Speed, Auto & Overdrive - 70.25" long.....	DC-A9A-17260.....	\$20
56 Seal - Speedometer Cluster to Dash Seal - Rubber.....	DC-B6C-17310-S.....	\$6
56 Grommet - Speedometer Cable to Firewall Grommet.....	DC-48-17265.....	\$3
Above also used as 56 Ford Gas Line Grommet - Use where line goes through floor		
32-58 Floor Shifter Knob - HD 3 Speed & 4 Speed.....	DC-BB-7213-A.....	\$8
37-52 Floor Shifter Knob - 3 Speed.....	DC-91C-7213	\$16
48-55 Gear Shift Knob - Ball Shape.....	DC-7C-7213.....	\$7
56-60 Gear Shift Knob - Elongated Oval Shape.....	DC-B6C-7213	\$8



Frame

53-56 Cab Mount Wing - LH.....	CMW-0736-L.....	CALL
53-56 Cab Mount Wing - RH.....	CMW-0736-R.....	CALL
53-56 Frame Horn - Front - LH Frame Rail.....	CMW-4002-L.....	\$45
53-56 Frame Horn - Front - RH Frame Rail.....	CMW-4002-R.....	\$45
48-52 Frame Horn Covers - Front - Polished Stainless Steel.....	CMW-0606-4852.....	\$49
53-56 Frame Horn Covers - Front - Polished Stainless Steel.....	MEF-BAAA-17752-SS.....	\$49



Frame Boxing Plates

53-56 Front Frame Boxing Plates - Set of 2.....	CMW-0010.....	\$59
53-56 Rear Frame Boxing Plates.....	CMW-0012.....	\$45
53-56 Rear Frame Boxing Plates & 4" C-Notch Brackets For Lowered Trucks.....	CMW-0012.....	\$69



**Buy Online @
www.CMWTrucks.com**



**Scan The QR Code With Your Mobile
Phone's Camera to go to our website**



**Our Website Can Be Very
Helpful In Building Your Truck**

Fuel System

» Fuel Tanks & Parts

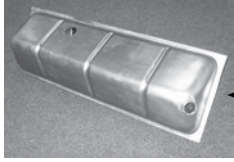

Stock Fuel Tanks & Accessories

48-52 Gas Tank - Stock Type.....	DC-7C-9002.....	\$275
53-55 Gas Tank - 17 gallon - OEM Fit - Steel.....	OVL-53F-9310.....	\$229
56 Gas Tank - In Cab - Steel.....	AMD-890-4556-18.....	\$219
42-52 Gas Tank Mounting Pads.....	DC-21C-9299.....	\$8
48-52 Gas Tank to Floor Bumpers - Set of 4.....	DC-01A-16188.....	\$5
53-55 Gas Tank Strap Set - For Stock Under Cab Tank.....	ACP-FP-EG028AS.....	\$29
53-55 Gas Tank Strap Insulators - Pair.....	PMC-81621-G.....	\$10
53-56 Gas Filler Pipe - Steel.....	PMC-1614-K.....	\$35
53-56 Gas Filler Pipe - Chrome.....	PMC-1614-CH.....	\$46
42-52 Ford Gas Tank Connection Hose.....	DC-21A-9047.....	\$ 8
53-77 Gas Tank Connection Hose - 1-7/8 Inch Diameter x 6 Inches.....	CMW-BAAA-9047-R.....	\$12.50
53-55 Gas Sender Inspection Plate (Cab Floor).....	CMW-2133.....	\$15



Fuel Neck Grommets

42-52 Grommet - Fuel Neck Grommet.....	DC-7C-9080-A.....	\$18
53-55 Grommet - Fuel Neck.....	DC-BAAA-9080-B.....	\$30
53-55 Fuel Neck Filler Metal Patch Piece.....	CMW-1650.....	\$17
56 Fuel Neck Filler Hole Patch Piece.....	CMW-1650-56.....	\$15
56 Grommet - Fuel Neck - Exactly Like Original.....	DC-B6C-9080.....	\$15
56 Grommet - Fuel Neck - Replacement.....	DC-CITZ-9080-A.....	\$10



Gas Caps

32-50 Gas Cap - Locking With Keys & Flipper Cover - Ford Script.....	DC-48-18416.....	\$35
51-70 Gas Cap - Non locking.....	OVL-38-18416-SS.....	\$9
1-70 Gas Cap - Locking With 2 Keys.....	UAP-S1301.....	\$16



Fuel Lines

56 Grommet - Speedometer Cable to Firewall Grommet.....	DC-48-17265.....	\$3
---	------------------	-----

Above also used as 56 Ford Gas Line Grommet - Use where line goes through floor

Gas Pedal & Linkage

48-56 Gas Pedal Pad.....	DC-TAAA-9735-A.....	\$17
48-52 Gas Pedal Rod.....	DC-7HC-9738-C.....	\$10
48-52 Gas Pedal Rod Spring.....	DC-7HC-9760-C.....	\$3
53-56 Gas Pedal Linkage Swivel.....	DC-TAAA-9725-C.....	CALL

Fits: 1953-1956 Standard transmission 6 cylinder. Fits: 1954-1956 Standard transmission V-8 for any engine installation with left side of carburetor linkage.



Fuel Sending Units For OEM Type Fuel Tanks



39-55 Fuel Sending Unit - 6V or 12V.....	DC-99A-9275.....	\$43
Use with original dash gauge only.		
48-55 Fuel Sending Unit - 6 volt.....	DAL-01A-9275-6V.....	\$39
36-55 Fuel Sending Unit - 6 volt - 14-140 Ohms.....	ACP-FP-EF024.....	\$39
53-55 Fuel Sending Unit - 6 or 12 volt - 14-140 Ohms.....	ACP-FP-EF025A.....	\$39
53-55 Fuel Sending Unit - 12 volt - Stock Tank/Gauges.....	DAL-01A-9275-12V.....	\$39
53-55 Fuel Sending Unit - 12 volt - Aftermarket Gauges 33-240 Ohms.....	ACP-EF025AM.....	\$44
Use with aftermarket gauges with ohm rating of 33-240.		
56 Fuel Sending Unit - 12 volt - Stock Tank/Gauges.....	OVL-56F-9300.....	\$39
56 Fuel Sending Unit - 12 volt - 14-140 Ohms - Stock Tank/Gauges.....	ACP-FP-EF025B.....	\$39
56 Fuel Sending Unit - 12 volt - Aftermarket Gauges 33-240 Ohms - Stock Tank.....	ACP-FP-EF025BM.....	\$44
Use with aftermarket gauges with ohm rating of 33-240.		

Fuel Sending Unit Parts



48-79 Gas Sending Unit Float - Brass.....	DAL-01A-9202.....	\$9
32-75 Gas Sending Unit Float - *New Design* Solid w/Brass Cap.....	DC-68-9275-S.....	\$6
Fits just as the original float. Will not leak and sink as original soldered type might.		
36-60 Gasket - Fuel Sending Unit Gasket.....	DAL-68-9276.....	\$2

Buy Online & Save @
www.CMWTrucks.com



**Scan The QR Code With Your Mobile
 Phone's Camera to go to our website**



Check our website for on-sale items!

Instrument Panel



48-50 Instrument Panel Decal Set - Speedometer Assembly & Gauges.....	DC-7C-17255-DF.....	\$50
51-52 Speedometer Assembly - New.....	DC-1C-17255-A.....	\$245
53-55 Dash Lens Glass - Clear.....	CMW-2613-5355C.....	\$22
53-55 Seal - Instrument Panel to Dash.....	LM-49-6203.....	\$9
56 Dash Instrument Panel Bezel - Chrome.....	OVL-56F-9271.....	\$69
56 Dash Lens Glass - Clear.....	CMW-2613-56C.....	\$22
56 Seal - Instrument Panel to Dash.....	LM-49-6202.....	\$7

Billet Aluminum Dash Panels - For Aftermarket Gauges



48-50 Billet Aluminum Dash Insert - 2 Hole - (2) 3-3/8".....	EZW-FORD-TRK-48-50-2H.....	\$130
48-50 Billet Aluminum Dash Insert - 3 Hole - (2) 3-3/8" & (1) 2-1/16".....	EZW-FORD-TRK-48-50-3H.....	\$130
48-50 Billet Aluminum Dash Insert - 5 Hole - (1) 3-3/8" & (4) 2-1/16".....	EZW-FORD-TRK-48-50-5H.....	\$130
51-52 Billet Aluminum Dash Insert - 2 Hole - (2) 3-3/8".....	EZW-FORD-TRK-51-52-2H.....	\$130
51-52 Billet Aluminum Dash Insert - 5 Hole - (1) 3-3/8" & (4) 2-1/16".....	EZW-FORD-TRK-51-52-5H.....	\$130
53-55 Polished Aluminum Dash Insert - 5 Hole - (1) 3-3/8" & (4) 2-1/8".....	EZW-FORD-TRK-53-55-5H.....	\$130
53-55 Polished Aluminum Dash Insert - 2 Hole - (2) 5".....	EZW-FORD-TRK-53-55-5.....	\$130
53-55 Polished Aluminum Dash Insert - 2 Hole - (2) 3-3/8".....	EZW-FORD-TRK-53-55-3-3/8.....	\$130
53-55 Polished Aluminum Dash Insert - 3 Hole - (3) 3-3/8".....	EZW-FORD-TRK-53-55-3H.....	\$130

Dash



48-59 Starter Button.....	DC-2C-11500.....	\$22
48-50 Radio Hole Cover - Beige.....	DC-7C-8104371.....	\$22
48-50 Radio Hole Cover - Chrome Plated Plastic.....	DC-7C-8104371-CC.....	\$38
48-50 Radio Speaker Grille - Beige.....	DC-7C-8104352.....	\$22
48-50 Radio Speaker Grille - Chrome.....	DC-7C-8104352-CC.....	\$35
53-55 Door & Dash Trim Set - Stainless Steel - With Install Clips.....	DC-BAAA-8120960-S.....	\$99

Steering Column

53-60 Steering Column to Dash Bracket Anti-Squeak.....	DC-TAAA-3693.....	\$3
--	-------------------	-----

» Dash Knobs & Bezels

Knobs for Dash

48-50 Knob - Choke	DC-7C-9703	\$8
51-52 Knob - Choke	DC-1C-9703-A	\$8
53-56 Knob - Choke, Defrost, Heater, Temp or Throttle	DC-BAAA-9700	\$6 each
48-50 Knob - Heater Control	DC-7C-9700	\$8
51-52 Knob - Heater Control	DC-1C-9700	\$8
48-50 Knob - Throttle - Black With a Red "T"	DC-7C-9778	\$8
51-52 Knob - Throttle - Black With a White "T"	DC-1C-9778-A	\$8
53-56 Knob - Turn Signal - Ball	DC-1A-13305	\$6
 53-56 Knob - Cowl Vent With Fastner	DC-BAAA-8102145	\$7
48-50 Knob - Cigar Lighter	DC-7C-15052	\$9
51-52 Knob - Cigar Lighter	DC-1C-15052-A	\$9
53-56 Knob - Cigar Lighter	DC-BAAA-15052	\$7
48-52 Knob - Wiper Switch - Check For Application	DC-1C-17513-A	\$6
51-52 Knob - Wiper Switch - Electric Wipers ONLY	DC-2C-17513-A	\$7
53-56 Knob - Wiper Switch	DC-BAAA-17513	\$7
53-60 Nut - Wiper Switch to Dash	DC-B7C-17512-A	\$9
48-50 Knob - Ash Tray	DC-7C-8101656	\$7
53-56 Knob - Glove Box Door & Ash Tray	DC-BAAA-8101656	\$6
48-50 Knob - Headlight Switch Knob With Shaft	DC-7C-11661	\$10
51-52 Knob - Headlight Switch Knob With Shaft	DC-1C-11661-A	\$9
53-55 Knob - Headlight Switch Knob With Shaft	DC-BAAA-11661	\$9
56 Knob - Headlight Switch Knob With Shaft	DC-B6C-11661	\$9
 53-54 Nut - Headlight Switch to Instrument Panel	DC-FAB-11662-A	\$7
55-64 Nut - Headlight Switch to Instrument Panel	DC-C2TZ-11650-A	\$9

Dash Knob Bezels

48-50 Bezel - Ignition Switch Dash Bezel	DC-0A-11580	\$15
51-52 Bezel - Ignition Switch Dash Bezel	DC-0L-11580	\$16
53-56 Bezel Kit - 5 Bezels - Ignition, Choke, Throttle, Wiper, Headlight	DC-BAAA-10852-KIT	\$37.50
53-56 Bezel - Choke	DC-BAAA-10852-C	\$8
 53-56 Bezel - Ignition Cylinder	DC-BAAA-10852-IG	\$8
53-56 Bezel - Wiper	DC-BAAA-10852-W	\$8
53-56 Bezel - Throttle	DC-BAAA-10852-T	\$8
53-56 Bezel - Headlight	DC-BAAA-10852-L	\$8
56-60 Ignition Switch to Dash Spacer (Mount Plate)	DC-B7C-11597-A	\$11

» Lighter & Glove Box

Cigar Lighter

48-55 Lighter Element & Well Assembly - 6 volt.....	DC-11A-15055	\$22
56-66 Lighter Element & Well Assembly - 12 volt.....	DC-B6C-15055.....	\$17

Glove Box

48-52 Glove Box Door Spring.....	DC-8C-8106068	\$6
48-52 Glove Box Liner - Larger Version	DC-1C-8106010.....	\$27
48-52 Glove Box Liner - Smaller Version	DC-7C-8106010.....	\$25
53-55 Glove Box Liner	DC-BAAA-8106010.....	\$24
56 Glove Box Liner	DC-B6C-8106010	\$25
48-52 Glove Box Door Bumpers - Pair	DC-1A-7006066	\$3 pair
53-66 Glove Box Door Bumpers - Pair	DC-0A-16378	\$3 pair
53-56 Knob - Glove Box Door & Ash Tray.....	DC-BAAA-8101656	\$6

Firewall Covers

53-55 Firewall Cover - w/ Pre-Cut Holes - ABS - With Insulation	DC-BAAA-8101670-ABS.....	\$260
53-56 Firewall Cover - Fiberglass - No Logo - No Insulation - No Clips.....	DC-B6C-8101670-A.....	\$279
32-79 Firewall Cover Clip - Plastic.....	DC-390018-S.....	\$2
32-79 Firewall Cover Clip - Metal.....	DC-48-7001670-CLIP	\$3.50

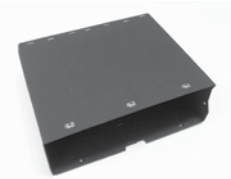

Interior Door Parts

51-56 Door Armrest Set - Black - Pair.....	DC-BAAA-8124141.....	\$55 pair
Door & Window Handle Clip Removal Tool.....	LM-31-0800.....	\$10
53-55 Door & Window Crank Handle Clip.....	DC-357550-S.....	\$0.50 each
48-52 Door Handle - Inside.....	DC-7C-8122614.....	\$15
53-55 Door Handle - Inside With Clip.....	DC-B5C-8122600-A.....	\$15
56 Door Handle - Inside.....	DC-B6C-8122600.....	\$15
48-50 Escutcheon For Window / Door Handle.....	DC-7C-8122618.....	\$10
51-52 Escutcheon For Window / Door Handle.....	DC-1C-8122618.....	\$12
53-55 Escutcheon For Window / Door Handle (Stainless Steel & Rubber Ring).....	DC-BAAA-8122618.....	\$8
53-55 Window Handle Escutcheon Spring.....	DAL-B-48284.....	\$1
56 Escutcheon For Window / Door Handle.....	DC-B6C-8122618.....	\$8
53-55 Window Crank Handle - With Clip.....	DC-B5C-8123342.....	\$15
53-56 Window Crank Handle Knob - Black - With Install Pin.....	DC-BAAA-8123341.....	\$7
56 Window Crank Handle - Black Knob.....	DC-B6C-8123342.....	\$15



Door Trim - Custom Cab

53-55 Door & Dash Trim Set - Stainless Steel - With Install Clips.....	DC-BAAA-8120960-S.....	\$159
53-56 Door Handle Shield Set - Polished Stainless Steel.....	DC-BAAA-8122405-S.....	\$29
56 Custom Cab Window Trim Joint Clip - Stainless Steel.....	CMW-1218-RP.....	\$3
56 Stainless Trim For Outside Door Around Window Opening - With Clips.....	DC-B6C-8120910-PR.....	\$169 pair
56 Door Trim installation clips - Set of 22.....	DC-B6C-8120915-S.....	\$15 set

NOT OE type - Grind a slot in the trim piece to use.



Door Panels & Inspection Plate

53-56 Door Inspection Plate - Steel.....	CMW-2126-STL.....	CALL
53-56 Door Inspection Plate Gasket - Pair.....	PMC-2126-GSKT.....	\$19 pair
51-52 Door Panel - Gray - Pair.....	DC-1C-8123890-GR.....	\$25 pair
51-52 Door Panel - Black - Pair.....	DC-1C-8123890-BL.....	\$25 pair
51-52 Door Panel - Brown - Pair.....	DC-1C-8123890-BR.....	\$25 pair
53-55 Door Panel - Gray - Pair.....	DC-BAAA-8123890-PR.....	\$50 pair
53-55 Door Panel - Black - Pair.....	DC-BAAA-8123890-BL.....	\$50 pair
56 Door Panel - Gray - Pair.....	DC-B6C-8123890-PR.....	\$50 pair
56 Door Panel - Black - Pair.....	DC-B6C-8123890-BL.....	\$50 pair
53-56 Clips to Hold Door Panels Set - Enough For Both Doors.....	DC-BAAA-8120018.....	\$18 set



» Panels, Visors & Belts

Kick Panels

48-52 Kick Panel Set - Gray	DC-7C-8102340-GR	\$30 pair
48-52 Kick Panel Set - Black	DC-7C-8102340-BL	\$30 pair
48-52 Kick Panel Set - Brown	DC-7C-8102340-BR	\$30 pair
53-55 Kick Panel Set - Gray	DC-BAAA-8102340-PR	\$30 pair
53-55 Kick Panel Set - Black	DC-BAAA-8102340-BL	\$30 pair
56 Kick Panel Set - Gray	DC-B6C-8102340-PR	\$30 pair
56 Kick Panel Set - Black	DC-B6C-8102340-BL	\$30 pair

Kick Panel Clips & Custom Retainers

48-52 Kick Panel Clip Set - Enough For Both Doors	DC-7C-8102342	\$5
53-55 Kick Panel Retainers - Pair - Polished Stainless Steel	MEF-BAAA-8102354-SS	\$25 pair
56 Kick Panel Retainers - Pair - Polished Stainless Steel	MEF-B6C-8102354-SS	\$25 pair

Sun Visors

48-52 Sun Visor Bracket - Plain Steel	DC-7C-8104144-PP	\$20 each
48-52 Sun Visor Bracket - Chrome	DC-7C-8104144-CC	\$33 each
53-55 Sun Visor Bracket & Rod - Plain Steel	DC-BAAA-8104144-PP	\$20 each
53-55 Sun Visor Bracket & Rod - Chrome	DC-BAAA-8104144-CC	\$33 each
56-60 Sun Visor Bracket & Rod - Plain Steel	DC-B6C-8104144-AP	\$20 each
56-60 Sun Visor Bracket & Rod - Chrome	DC-B6C-8104144-CC	\$33 each
53-55 Sun Visor Bracket Pad - Rubber - With Bead	DC-BAAA-8104144-BRP	\$8
56-60 Sun Visor Bracket Pad - Rubber - With Bead	DC-B6C-8104144-BRP	\$8
48-56 Sun Visor Bracket Screws - Stainless Steel - Set of 3	DC-52353-SS	\$1 set
48-52 Sun Visor Pad - Gray - Sold Each	DC-7C-8104104-GR	\$28 each
48-52 Sun Visor Pad - Black - Sold Each	DC-7C-8104104-BL	\$28 each
48-52 Ford Truck Sun Visor - Brown - Sold Each	DC-7C-8104104-BR	\$28 each
53-55 Sun Visor Pad - Gray - Sold Each	DC-BAAA-8104104	\$28 each
53-55 Sun Visor Pad - Black - Sold Each	DC-BAAA-8104104-BL	\$28 each
56 Sun Visor Pad - Gray - Sold Each	DC-B6C-8104104-AA	\$28 each
56 Sun Visor Pad - Black - Sold Each	DC-B6C-8104104-BL	\$28 each



Back of Cab

53-55 Back of Cab Interior Panel - Gray	DC-BAAA-8142414	\$75
53-55 Back of Cab Interior Panel - Black	DC-BAAA-8142414-BL	\$75

Seat Belt

53-56 Seat Belt Mounts - Upper Shoulder - Pair - Small Window Only	CMW-2180	\$150
Seat Belt Floor Mount Washer - Large	CMW-2187-FW	\$3 each



Seat Belt Mounts
CMW-2180

Floor

- 48-52 Front Floor Mat - Black - Rubber - No Holes - No Jute backing..... DC-8C-8113000-U..... \$139
 - 48-52 Front Floor Mat - Black - Rubber - Pre-Cut Holes - No Jute backing..... DC-8C-8113000..... \$149
 - 53-56 Rubber Floor Mat - Black - No Jute backing..... DC-BAAA-8113000..... \$125
- Covers the front part of the floor (in front of the bench seat - Does not cover under the seat)

Pedals - Gas & Brake



- 41-56 Pedal Pad - Brake or Clutch - OE Style..... DC-11A-2454..... \$11 each
- 40-52 Brake Pedal Return Spring..... DC-01T-2472..... \$4
- 53-56 Brake Pedal Return Spring..... DC-TAAA-2472-A..... \$5
- 42-52 Brake Pedal Arm to Master Cylinder Bolt..... DC-21C-2462-A..... CALL
- 48-56 Brake & Clutch Pedal Arm Bumpers (Rubber)..... DC-7C-2473..... \$6 pair
- 48-52 Brake & Clutch Pedal Bushing..... DC-B-7526-A..... \$4 each
- 53-56 Brake & Clutch Pedal Bushing - F100 to F500..... DC-7EQ-5344-A..... \$3 each
- 48-56 Gas Pedal Pad With Pivot & Moulded Ball Mount..... DC-TAAA-9735-A..... \$17

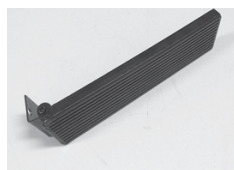

Firewall Insulation & Cover

- 48-52 Firewall Cover - With Pre-Cut Holes & Insulation - ABS - No Clips..... DC-7C-8101670-ABS..... \$260
- Includes Attached Insulation. Formed to fit original firewall. NO Ford logo on this one. Needs 11 clips.
- 53-55 Firewall Cover - With Pre-Cut Holes & Insulation - ABS - No Clips..... DC-BAAA-8101670-ABS..... \$260
- Includes Attached Insulation. Formed to fit original firewall. NO Ford logo on this one. Needs 9 clips.
- 56 Firewall Cover - With Pre-Cut Holes & Insulation - ABS - No Clips..... DC-B6C-8101670-ABS..... \$260
- Includes Attached Insulation. Formed to fit original firewall. NO Ford logo on this one. Needs 10 clips.
- 32-79 Firewall Cover Push In Clip - Plastic..... DC-390018-S..... \$2 each
 - 32-79 Firewall Cover Push In Clip - Metal..... DC-48-7001670-CLIP..... \$3 each
 - 53-56 Steering Column to Floor Seal - Column Shift - 3 pc Kit - OE Type..... DC-BAAA-3513..... \$8
 - 53-56 Steering Column to Floor Seal - Floor Shift - 3 pc Kit - OE Type..... DC-BAAA-3513-A..... \$8



Headliner - Small Back Window Only

- 48-52 Headliner - 8 pc - Like Original - Incl Hardware - Gray..... DC-7C-8151968-GR..... \$225
 - 48-52 Headliner - 8 pc - Like Original - Incl Hardware - Black..... DC-7C-8151968-BL..... \$225
 - 48-52 Headliner - 8 pc - Like Original - Incl Hardware - Brown..... DC-7C-8151968-BR..... \$225
 - 53-55 Headliner - Roof Only - OE Gray - No Clips..... DC-B5C-8151968-AA..... \$159
 - 53-55 Headliner - Roof Only - OE Black - No Clips..... DC-B5C-8151968-BL..... \$159
 - 56 Headliner - Roof Only - OE Gray - No Clips..... DC-B6C-8151968..... \$159
 - 56 Headliner - Roof Only - OE Black - No Clips..... DC-B6C-8151968-BL..... \$159
- Headliners are shipped Oversized and require additional cost



- 53-56 Seal - Headliner - Holds Headliner in Place..... DC-BAAA-8150956..... \$18.50
- 48-52 Headliner Install Hardware Kit..... DC-7C-8150960-S..... \$18
- 53-56 Headliner Clip..... DC-BAAA-8150960..... \$.50 each
- 53-56 Headliner Clip - Set of 16..... DC-BAAA-8150960-S..... \$7/ set



Windshield Wipers

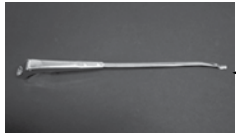

48 - 52 Ford Truck Wiper Arm - OEM Type - LH or RH.....	DC-1C-17526	\$17
53-55 Wiper Arm - LH or RH.....	OVL-54-17527	\$17
56-60 Wiper Arm - LH.....	OVL-54-17527	\$17
56-60 Wiper Arm - RH.....	OVL-54-17526	\$17



48 - 52 Ford Truck Wiper Blade - OEM Type - LH or RH - 10"	DC-A8C-17528-A	\$15
53-60 Wiper Blade - LH or RH - 12"	OVL-55-17528	\$13



48-55 Grommet - Wiper Arm to Motor	DC-51A-17562	\$4 each
48-60 Clip - Wiper Arm - Goes Under Dash to Motor	DC-06H-17531	\$2 each
48-60 Wiper Pivot Repair - Knurl Nut Replacement - Pair	DC-8A-17566-K	\$25 pair
48-55 Nut For Wiper Pivot Assembly - Chrome	DC-356094-S	\$6 each
56 Nut For Wiper Pivot Assembly - Chrome	DC-356095-S	\$6 each

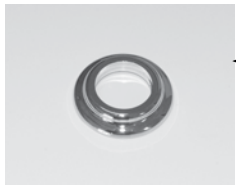

51-52 Wiper Pivot Assembly - LH - Electric Wiper Motor Only	DC-7C-17567-A	\$30
51-52 Wiper Pivot Assembly - RH - Electric Wiper Motor Only	DC-7C-17566-A	\$30
53-55 Wiper Pivot Assembly - LH or RH	DC-BAAA-17566	\$32 each
56 Wiper Pivot Assembly - LH or RH	DC-B6C-17566	\$30 each



48-52 Bezel For Wiper Pivot Shaft/Assembly - LH	DC-7C-17515	\$13 each
48-52 Bezel For Wiper Pivot Shaft/Assembly - RH.....	DC-7C-17514	\$13 each
53-60 Bezel - Wiper Pivot Shaft/Assembly - LH or RH - Chrome.....	DC-BAAA-17515-A	\$8 each

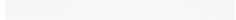

48-52 Gasket - Wiper Pivot Shaft/Assembly - Pair Does One Truck.....	DC-7C-17541	\$3 pair
53-60 Gasket - Wiper Pivot Shaft/Assembly - Pair Does One Truck.....	DC-BAAA-17541-A	\$3 pair

56 Grommet - Wiper Motor Cable	DC-8A-14605-A	\$2
53-56 Grommet - Wiper Hose	DC-BAAA-17545	\$3

53-56 Switch - Wiper - 12 volt.....	DC-B6C-17470-A	\$43
53-60 Nut - Wiper Switch to Dash	DC-B7C-17512-A	\$9

48-52 Knob - Wiper Switch - Check For Application.....	DC-1C-17513-A	\$6
51-52 Knob - Wiper Switch - Electric Wipers ONLY.....	DC-2C-17513-A	\$7
53-56 Knob - Wiper Switch.....	DC-BAAA-17513	\$7

48 - 56 Windshield Washer Pedal Pad - Foot Operated.....	DC-8A-17664-P.....	\$3
--	--------------------	-----

48-66 Windshield Washer Pump Rubber.....	DC-8A-17664-RP	\$15
--	----------------------	------

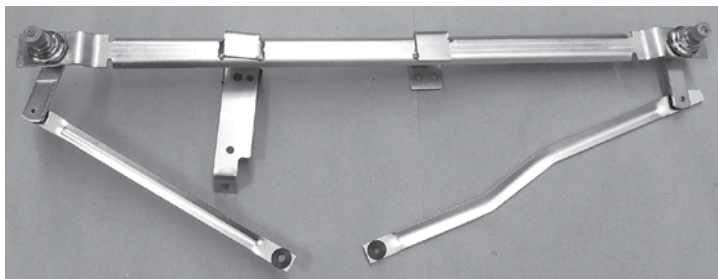

53-55 Wiper Linkage Assembly - Kit	CPP-5355WLK	\$159
--	-------------------	-------



DC-BAAA-17508



DC-B6C-17508-RR

**12 Volt
2 Speed
Motor**

Windshield Wiper Conversions - Electric

48-52 Wiper Motor - 12v Electric Type With Mounting Bracket & 2 Speeds	DC-7C-17508	\$275
51-52 Wiper Motor - 12v Electric Type With Mounting Bracket & 2 Speeds	DC-1C-17508	\$150
53-55 Wiper Motor - 12v Electric Type With Mounting Bracket & 2 Speeds	DC-BAAA-17508	\$150
56-60 Wiper Motor - 12v Electric Type With Mounting Bracket & 2 Speeds	DC-B6C-17508-RR	\$150



Books

1948 Ford Truck Owners Manual.....	OSB-111481.....	\$12
1949 Ford Truck Owners Manual.....	OSB-111491.....	\$12
1950 Ford Truck Owners Manual.....	OSB-111501.....	\$12
1951 Ford Truck Owners Manual.....	OSB-111511.....	\$12
1952 Ford Truck Owners Manual.....	OSB-111521.....	\$12
1953 Ford Truck Owners Manual.....	OSB-111531.....	\$12
1954 Ford Truck Owners Manual.....	OSB-111541.....	\$12
1955 Ford Truck Owners Manual.....	OSB-111551.....	\$12
1956 Ford Truck Owners Manual.....	OSB-111561.....	\$12
1949-52 Ford Truck Shop Manual.....	OSB-SM0073.....	\$30
1954-55 Ford Truck Shop Manual.....	OSB-SM0070.....	\$39
1953 Ford Truck Body/Interior Assembly Manual.....	OSB-AM0145.....	\$21
1954 Ford Truck Body/Interior Assembly Manual.....	OSB-AM0147.....	\$26
1953 Ford Truck Illustrated Facts/Features Manual.....	OSB-MP0378.....	\$10
1954 Ford Truck Illustrated Facts/Features Manual.....	OSB-MP0379.....	\$10
1955 Ford Truck Illustrated Facts/Features Manual.....	OSB-MP0380.....	\$10
1956 Ford Truck Illustrated Facts/Features Manual.....	OSB-MP0381.....	\$10
48-56 Ford Truck Parts Catalog.....	CMW-5356Ford-Cat.....	\$0

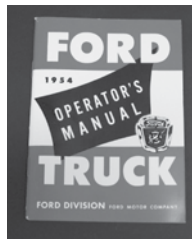

1954 Owners Manual



1954-55 Shop Manual



1955 Owners Manual



1956 Owners Manual



1956 Shop Manual
(Discontinued)

Air Deflectors.....	pg 23	Instrument Panel.....	pgs 42, 54-55
Antenna.....	pgs 11, 43	Interior Door Parts.....	pg 12, 57
Anti-Rattle Kits & Parts.....	pg 15	Kick Panels.....	pg 58
Back Window Glass.....	pg 16	Knobs for Dash.....	pgs 42, 48, 49, 55, 60
Battery.....	pgs 11, 43	License Plate.....	pg 47
Bed Front & Bedsides.....	pg 5	Master Cylinders - Single & Dual w/Booster.....	pg 31-33
Bed Sills & Crossmembers.....	pg 5	Mirrors.....	pg 15
Bed Strips & Floor.....	pgs 5-6	Mustang II Front Suspension.....	pg 39
Beds - Complete.....	pgs 2-4	One Piece Door Window Kits.....	pg 18
Books.....	pg 61	Parking Brakes.....	pg 32
Brakes.....	pg 31-34	Parking Lights.....	pgs 44-45
Bumper - Front.....	pg 8	Patch Panels.....	pgs 9, 26-29
Bumper - Rear.....	pg 8	Pedals - Gas & Brake.....	pgs 31, 52, 59
Cab.....	pgs 10-11, 26-28	Power Steering Kits.....	pg 36
Custom - IFS.....	pg 39	Power Window Kits.....	pg 18
Dash.....	pgs 54-56	Radiator Related.....	pgs 23, 25
Dash Knob Bezels.....	pg 55	Rear 4 Bar Suspension.....	pg 38
Dash Switches.....	pg 55	Roll Pans.....	pgs 8, 9, 30
Dome Lights.....	pg 43	Running Boards.....	pg 30
Door Glass.....	pg 16	Steering - Original Equipment.....	pg 35
Door Handles, Locks & Latches.....	pgs 12-14	Stock Suspension Lowering.....	pg 37
Door Hinges.....	pg 13	Striker Plates.....	pg 14
Door Inspection Plate.....	pgs 13, 57	Sun Visors.....	pg 58
Door Panels.....	pg 57	Suspension - Original.....	pgs 37-38
Emblems & Chrome.....	pg 20	Switches.....	pgs 42, 43, 44, 48, 60
Engine Mounts.....	pg 50	Tailgate & Related.....	pgs 6-7
Fender - Rear.....	pg 9	Taillight Brackets.....	pg 47
Firewall.....	pgs 11, 27	Taillights.....	pgs 46-47
Floor.....	pgs 5-6, 11, 27, 59	Transmission Covers.....	pgs 11, 27
Frame.....	pg 51	Transmission Mounts.....	pg 50
Front & Inner Fenders.....	pg 22	Turn Signals.....	pg 37
Front Disk Brakes.....	pg 34	Valance - Front.....	pgs 8, 21, 30
Fuel System.....	pgs 52-53	Vent Window Glass.....	pg 16
Gas Tanks.....	pg 52	Vent Window Parts.....	pgs 12-13
Gauge Panels.....	pg 54	Weatherstrip & Seals.....	pgs 17-18
Glass.....	pg 16	Wheel Cylinders.....	pg 31
Glove Box.....	pg 56	Wheels.....	pg 40
Grille.....	pgs 20-21	Window Parts - Door.....	pg 19
Headlights.....	pg 42	Windshield Glass.....	pg 16
Headliner.....	pg 59	Wipers.....	pg 60
Heater.....	pg 49	Wiring & Wire Accessories.....	pg 41
Hood - Related Parts.....	pgs 20, 24-25, 28	Wiring Harnesses.....	pg 41
Horn.....	pg 44		

CMW Trucks Parts Order Form

Date _____

<p>Personal Information</p> <p>Name _____</p> <p>Company Name _____</p> <p>Telephone _____</p> <p>Billing Address</p> <p>Street Address _____</p> <p>Add #2 _____</p> <p>City _____</p> <p>State/Province _____</p> <p>Zip Code _____</p> <p>Country _____</p>	<p>Shipping Information <input type="checkbox"/> Same as Billing Info.</p> <p>Name _____</p> <p>Company Name _____</p> <p>Telephone _____</p> <p>Shipping Address</p> <p>Street Address _____</p> <p>Add #2 _____</p> <p>City _____</p> <p>State/Province _____</p> <p>Zip Code _____</p> <p>Country _____</p>
---	--

Year _____ Make _____ Model _____

Part Number	Description	Qty	Price Per Unit	Total
_____	_____	_____	_____	_____
_____	_____	_____	_____	_____
_____	_____	_____	_____	_____
_____	_____	_____	_____	_____
_____	_____	_____	_____	_____
_____	_____	_____	_____	_____
_____	_____	_____	_____	_____
_____	_____	_____	_____	_____
_____	_____	_____	_____	_____
_____	_____	_____	_____	_____
_____	_____	_____	_____	_____
_____	_____	_____	_____	_____
_____	_____	_____	_____	_____
_____	_____	_____	_____	_____
_____	_____	_____	_____	_____
_____	_____	_____	_____	_____
_____	_____	_____	_____	_____
_____	_____	_____	_____	_____
_____	_____	_____	_____	_____
_____	_____	_____	_____	_____
_____	_____	_____	_____	_____
_____	_____	_____	_____	_____
_____	_____	_____	_____	_____
_____	_____	_____	_____	_____
_____	_____	_____	_____	_____
_____	_____	_____	_____	_____

Parts page 1 Total _____

Parts page 2 Total _____

Parts Total _____

Tax (Ohio Only) _____

Shipping _____





TOTAL _____

SEND YOUR ORDER IN

Make checks payable to:
CMW Trucks
 209 S. Hametown Rd.
 Copley, OH 44321

You may also use this sheet to fill in part #'s and order by phone

We accept the following credit cards

*Please do not write credit card information on this sheet